

.A R I A.

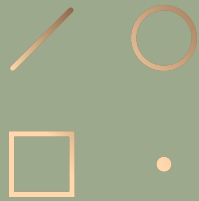















come to light

.A R I A.

We believe
in empowering choice

**IT Crediamo nel potere della scelta.
Offriamo ai designer soluzioni
minimaliste che si aprono a nuove
e infinite possibilità progettuali.
Forme pure, linee pulite e aperture
gentili che generano precise
performance luminose.
Follow the light.**

**EN We believe in empowering choice.
We provide designers minimalist
products with a multitude of options.
Pure shapes, clean lines and gentle
apertures that deliver precise
performance where needed.
Follow the light.**

	Product families	Pages
ARIA		8
Product families		Sistema lineare sospeso - 35 Suspended linear system - 35 10
		Incassi Downlights 36
		Sistemi da incasso Recessed systems 86
		Proiettori da semi-incasso/superficie Semi-recessed/surface spotlights 98
		Luci a binario Track lights 116
		Binari elettrificati Electrified tracks 148
		Luci da parete e plafone Wall and ceiling lights 168
		Sospensioni Pendants 176
		Profili - Stripled Profiles - LED Strips 190
		Incassi da terra per esterni Exterior ingrounds 208
		Incassi da parete per esterni Exterior recessed wall lights 222
		Proiettori per esterni Exterior projectors 234
		Luci da appoggio Bollards 252
		Luci da facciata Façade lights 264
		Luci da plafone per esterni Exterior ceiling lights 274
Contact		298

^{ITA} **L'illuminazione è da sempre un gioco che suscita stupore, uno strumento dai tratti quasi magici, che può plasmare scene artificiali e portare vita e movimento dove non c'è luce naturale. L'artificio si fa arte e il bagliore luminoso è un espediente accuratamente studiato per creare infinite forme di bellezza. I capitoli del catalogo Aria 2022 sono i fondali di scena della nostra personale idea di spettacolo, in cui il filo - elettrico, ma anche tematico, conduttore di energia - è una linea grafica che unisce l'elemento umano alle soluzioni di illuminazione del brand. Scena dopo scena, atto dopo atto, le famiglie di prodotti Aria sono protagoniste con le loro principali caratteristiche, per poi lasciar parlare gli "attori" con le immagini di prodotti e realizzazioni. Si spengono le luci in sala, si accendono quelle sul palcoscenico. L'immaginazione viene alla luce.**

^{EN} **Lighting has always been a game that arouses amazement, an instrument with almost magical features which can shape artificial scenes and bring life and movement where there is no natural light. Artifice becomes art, and the luminous glow is a carefully examined expedient to create infinite forms of beauty. The chapters of the Aria 2022 catalogue are the backdrop for our idea of a show, where the wire - an electric but also a thematic conductor of energy - is a graphic line that combines the human element with our lighting solutions. Scene after scene, act after act, the Aria product families are the protagonists with their main characteristics, and then let the "actors" speak with the images of products and creations. The lights in the hall switch off, and the lights on the stage switch on. Imagination comes to light.**

^{ITA} Aria lavora per sviluppare nuovi strumenti per le esigenze estetico-funzionali di designer e architetti. Soluzioni di illuminazione per interni ed esterni i cui prodotti sono studiati per creare vere e proprie performance luminose. Grazie ad un approccio ibrido tra creatività, essenzialità ed efficienza siamo in grado di offrire a designer ed architetti soluzioni dal design minimale e dalle alte prestazioni.

^{EN} Aria works to develop new tools for the aesthetic-functional needs of designers and architects. Lighting solutions for indoors and outdoors, whose products create out-and-out lighting performances. Thanks to a hybrid approach between creativity, essentiality, and efficiency, we can offer designers and architects solutions with minimal design and high performance.

**Sistema lineare
sospeso**

**Suspended
linear system**

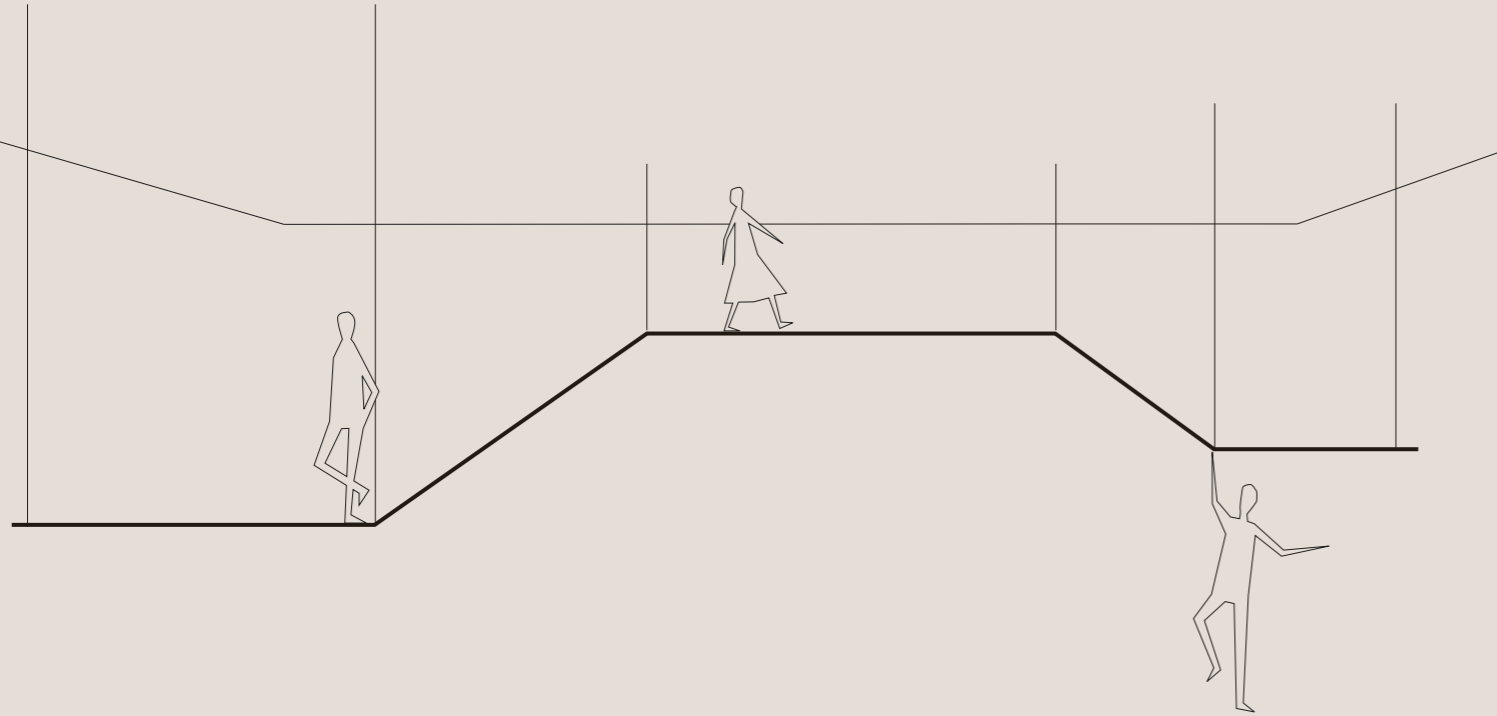

Trame di luce da seguire con lo sguardo

Textures of light to follow with the eyes

^{ITA} Linee luminose viaggiano attraverso gli ambienti, tracciando un percorso definito. Gli elementi lineari esplorano gli spazi da illuminare con luce diffusa o d'accento. La luce può dare vita ad atmosfere accoglienti e rilassanti o definire spazi con diverse funzioni.

^{EN} Bright lines move through the environments, tracing a defined path. The linear elements explore spaces, illuminating them with diffused and accent light. Lights contributes to a relaxing and welcoming atmosphere, as well as defines spaces with different functions.

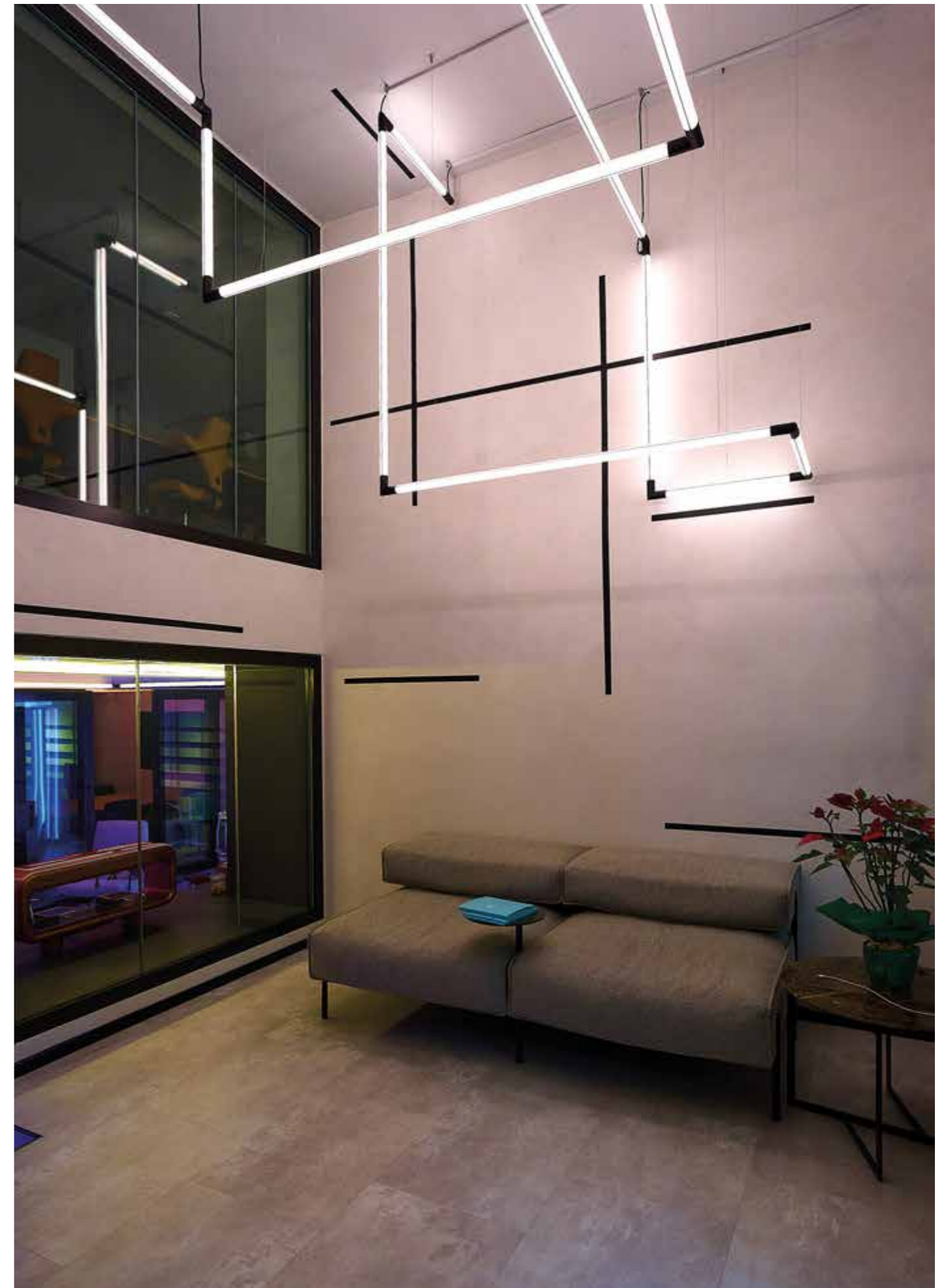

Jeb Showroom – Singapore
35 Linear System RGBW in configurazione custom / custom configuration of 35 Linear System RGBW





**Luminosa linearità per
personalizzare spazi e dar vita
ad atmosfere uniche.**

Luminous linearity to customise spaces
and create unique atmospheres.

^{ITA} Da quasi invisibile a rivelato, 35 crea dettagli nascosti o è il protagonista di un'installazione che lascia a bocca aperta. La sua sottigliezza traccia una linea minima tra dettagli funzionali, elementi grafici e aspetti decorativi utilizzando materiali, colori e luce.

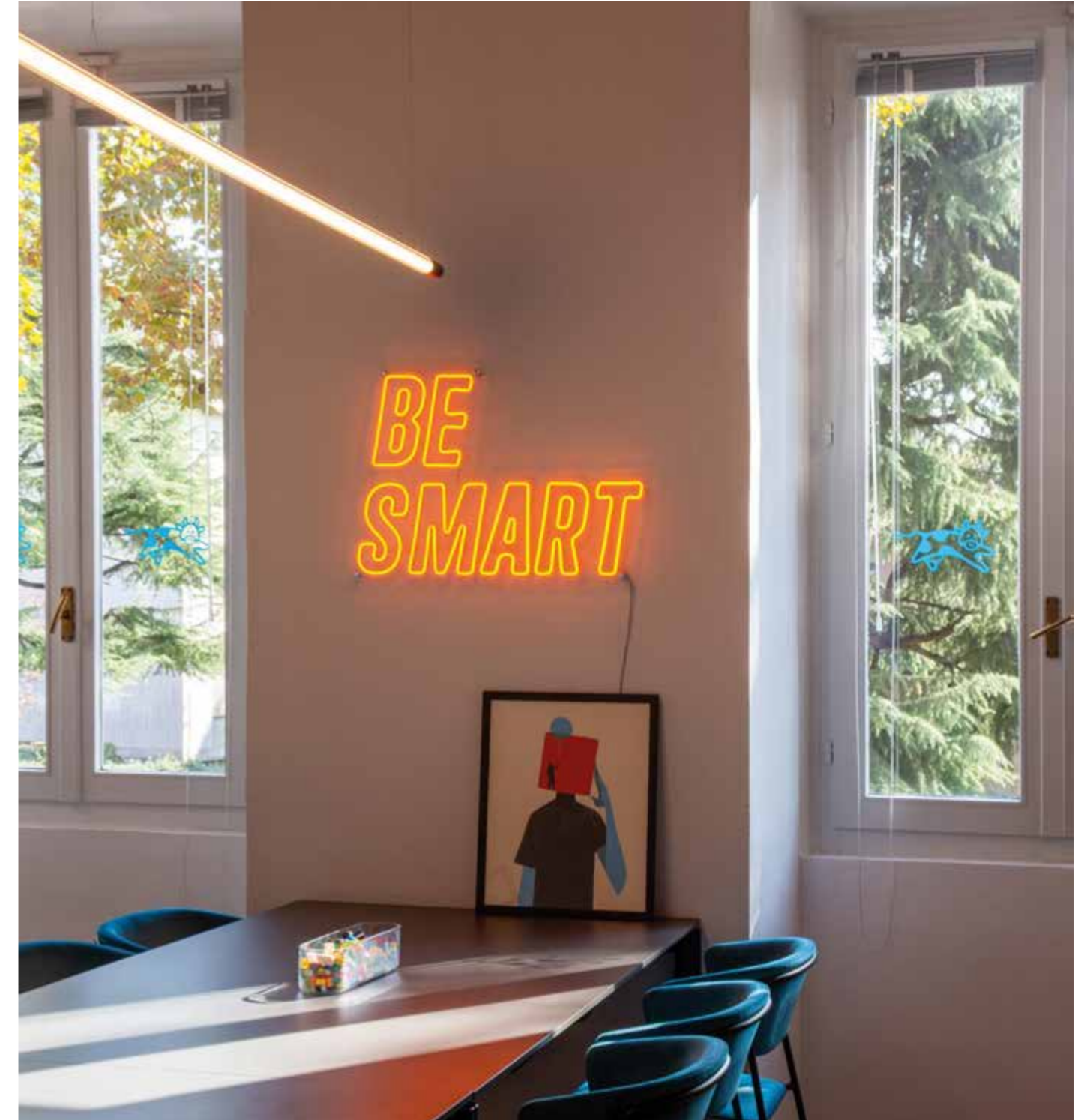

^{EN} From hidden to revealed, 35 can create concealed details or be the centerpiece of a breathtaking installation. Its subtleness draws a thin line between functional details, graphical statements and decorative features using materials, colors, and light.

Sistema lineare sospeso

Suspended linear system

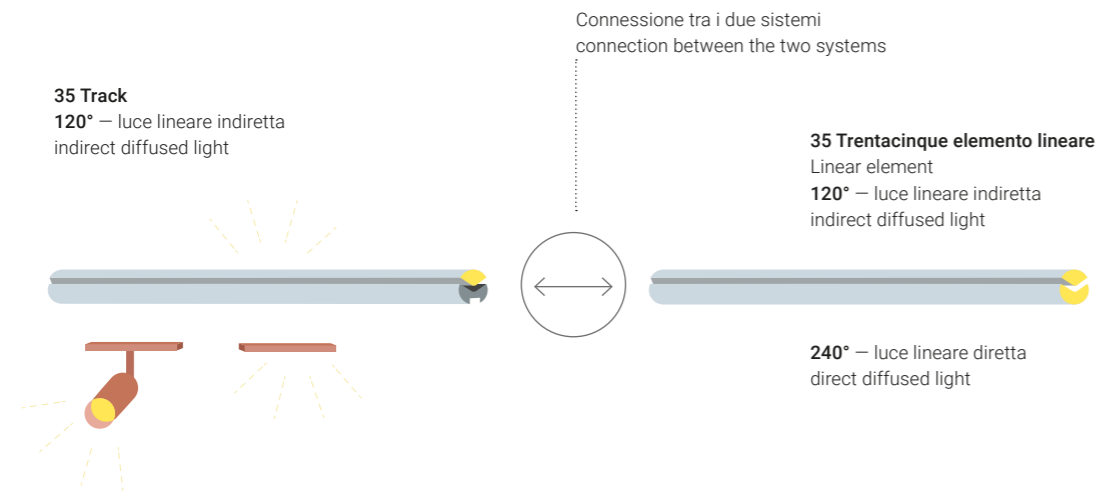

35 Track 120° Uplight + Nanoperfetto 48Vdc

Caratteristiche

Features

^{ITA} Il sistema lineare sospeso Trentacinque (35) svolge tre diverse tipologie di illuminazione: luce indiretta diffusa verso l'alto, luce diretta diffusa verso il basso, e luce d'accento. 35 Linear è un elemento cilindrico che crea luce diffusa verso l'alto e/o luce diffusa verso il basso. 35 Track unisce la morbidezza della luce diffusa indiretta tipica del 35 alla massima flessibilità d'uso e performance del binario 48V_{DC}, consentendo una maggiore possibilità di configurazione del sistema luminoso. Grazie a questi elementi modulari, il sistema Trentacinque (35) è facilmente configurabile per progettare l'illuminazione di uno spazio con una totale flessibilità di forme e funzioni.

In fase di installazione è possibile raggruppare gli elementi luminosi del Trentacinque (35) in diversi gruppi o scene, lasciando libertà di scelta di accensioni e di dimmerazione.

^{EN} 35 suspended linear system has three different types of light: indirect diffused uplight, direct diffused downlight, and accent lighting. 35 Linear is a cylindrical element that can create diffused uplight and/or diffused downlight. 35 Track combines diffused uplight, with the maximum flexibility and the extensive performance of the 48V_{DC} track, allowing for greater possibility of configuring the lighting system. Using these modular elements, the 35 system can be configured to shape the light as required, with flexibility in forms and functions.

The Trentacinque (35) can be wired into separate groups, allowing an independent control of the lighting components, and giving designers the freedom to create diverse architectural lighting installations.



**Sistema lineare
sospeso**

**Suspended
linear system**

^{ITA} Elemento lineare in alluminio anodizzato con diffusori in policarbonato; giunti di connessione in pressofusione di alluminio verniciato poliester.

^{EN} Linear element in anodized aluminium with diffusers in polycarbonate; connection joints in die-cast aluminium, polyester painted.

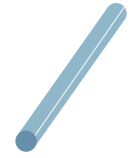

elemento lineare
linear element
(master + continuous)



giunto L
L joint



kit di sospensione
suspension kit



giunto flessibile
flexible joint

**35 track +
120° uplight**

**35 track +
120° uplight**

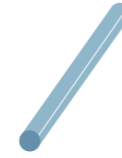

elemento lineare track
track linear element



proiettori 48V_{dc}
48V_{dc} spotlights



Miniroller
linea di luce d'accento
accent light line



Linea 48
linea di luce diffusa
diffused light line

linear element

L joint

suspension kit



diffused light line

accent light line

spotlight



Sistema lineare sospeso

Suspended linear system

Configurazione

Configuration

^{ITA} Tutti gli elementi lineari permettono la continuità elettrica all'elemento successivo con un giunto lineare integrato.

^{EN} Every linear element powers the next element through an integrated connection.

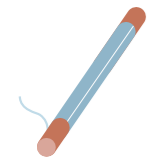

01 primo componente first component

^{ITA} elemento lineare master:
necessario come primo componente

^{EN} master linear element: compulsory
as first component

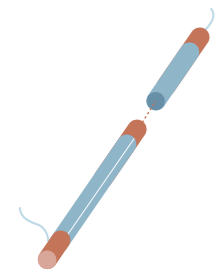

02 secondo componente second component

^{ITA} elemento lineare continuo
come possibile secondo componente

^{EN} continuous linear element
as possible second component

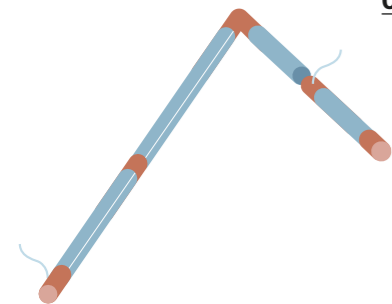

03 componenti successivi nuova alimentazione

continuous components
new power supply

^{ITA} terminati i Watt disponibili dal driver,
occorre inserire nuovamente un elemento
lineare master

^{EN} once the maximum wattage supplied
by the driver is reached, an additional 'first
component' is required

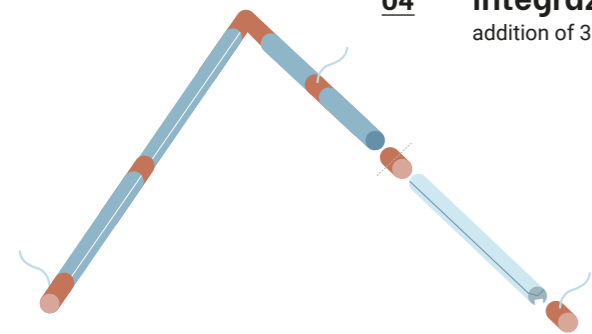

04 integrazione con 35 Track addition of 35 Track

^{ITA} tramite giunto meccanico dedicato,
lineare o a L, è possibile connettere uno
o più elementi di 35 Track, da alimentare
successivamente

^{EN} through dedicated mechanical linear or L
joint, it is possible to connect one or more
elements of 35 Track, to be feeded from
another point

Schemi di dimmerazione
scaricabili dal sito

Dimming schemes can be
downloaded from the web site



**Sistema lineare
sospeso**

**Suspended
linear system**



Finiture

Finishes

^{ITA} I sistemi 35 e 35 Track + 120° sono disponibili nelle finiture bianco o nero e con diffusori opale, fumé oppure nero, combinabili tra loro per adattarsi alle diverse esigenze progettuali.

^{EN} The 35 and 35 Track + 120° systems come as white or black as standard finishes. You can combine opal, smoked or black diffusers to get the most of your lighting project.



Esempio di configurazione con 35 Track, Miniroller 48V_{dc} e 35 sistema lineare sospeso, in finitura nera.

Configuration example with 35 Track, 48V_{dc} Miniroller and 35 linear suspended system, in black finish.



Diffusore fumé acceso
Smokey diffuser switched on

Il sistema lineare sospeso 35 è disponibile con due varianti di diffusore.

The 35 suspended linear system comes with two options of diffuser.

^{ITA} I diffusori sono accessori in grado di rendere 35 un prodotto ancor più completo. È possibile optare per il diffusore opale, che dà l'impressione di essere bianco quando spento, ma che dona un effetto elegante e fine al prodotto. In alternativa è disponibile anche il diffusore fumé, accattivante quando spento, ma delicato e d'atmosfera quando acceso.

^{EN} Diffusers are accessories capable of making 35 an even more complete product. You can either go for the opal diffuser which looks white when switched off but offers an elegant and delicate effect. Alternatively, the smoked diffuser is also available, attractive when turned off but good looking and atmospheric when turned on.

Sistema lineare
sospeso

Suspended
linear system



L'arabesque Cult Store – Milano (Architects: Giovanni Pacciani and Claudio Bignazzi - Lighting design: Flux CS)

35 Linear System RGBW in configurazione custom
Custom configuration of 35 Linear System RGBW



**Sistema lineare
sospeso**

**Suspended
linear system**



INDEX

Products

Pages

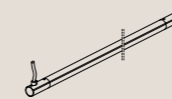

35 Trentacinque Master Linear Element

30



35 Trentacinque Continuous Linear Element

31



35 Trentacinque Continuous Linear Element off

33



35 Track

34

35 Trentacinque
ELEMENTO LINEARE MASTER / MASTER LINEAR ELEMENT



- 12 62 **Nero anodizzato + diffusore opale**
Anodized black + opal diffuser
- 04 62 **Bianco + diffusore opale**
White + opal diffuser

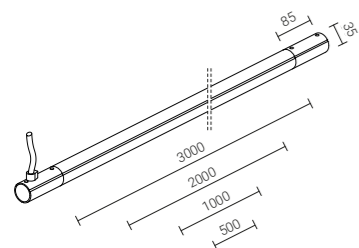

Codice Code	Lunghezza Length (mm)	LED Lumen	Product Lumen	Watt	Colour T (K)	CRI
Con due giunti lineari e diffusore in policarbonato opale. Doppia accensione 120° + 240°. Trasformatori e dimmer da ordinare separatamente / With two straight joints and diffuser in opal polycarbonate. Double switch 120° + 240°. Transformers and dimmers should be ordered separately.						
457-230059C	500	525 + 1050	293 + 586	5 + 10	2700	90
457-230059B	500	550 + 1100	307 + 614	5 + 10	3000	90
457-230109C	1000	1050 + 2100	586 + 1172	10 + 20	2700	90
457-230109B	1000	1100 + 2200	614 + 1228	10 + 20	3000	90
457-230209C	2000	2100 + 4200	1172 + 2344	20 + 40	2700	90
457-230209B	2000	2200 + 4400	1228 + 2456	20 + 40	3000	90
457-230309C	3000	3150 + 6300	1758 + 3517	30 + 60	2700	90
457-230309B	3000	3300 + 6600	1842 + 3684	30 + 60	3000	90

48Vbc



Per accessori vedi pag. 33. Per trasformatori e dimmer vedi pag. 35
For accessories see page 33. For transformers and dimmers see page 35

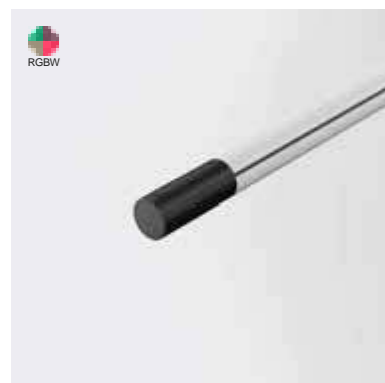

- 12 62 **Nero anodizzato + diffusore opale**
Anodized black + opal diffuser
- 04 62 **Bianco + diffusore opale**
White + opal diffuser

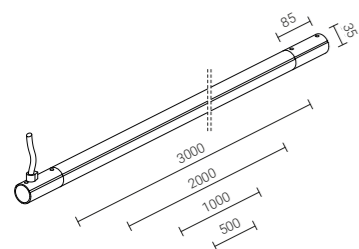

Codice Code	Lunghezza Length (mm)	LED Lumen	Product Lumen	Watt	Colour T (K)	CRI
Con due giunti lineari e diffusore in policarbonato opale. Singola accensione 360° - RGBW With two straight joints and diffuser in opal polycarbonate. Single switch 360° - RGBW						
477-13005EE	500	1161	649	15	RGBW 2700	90
477-13010EE	1000	2322	1300	30	RGBW 2700	90
477-13020EE	2000	4644	2601	60	RGBW 2700	90
477-13030EE	3000	6966	3891	90	RGBW 2700	90

48Vbc



Per accessori vedi pag. 33. Per trasformatori e dimmer vedi pag. 35
For accessories see page 33. For transformers and dimmers see page 35

35 Trentacinque
ELEMENTO LINEARE CONTINUO / CONTINUOUS LINEAR ELEMENT

Sistema lineare sospeso / Suspended linear system



- 12 62 **Nero anodizzato + diffusore opale**
Anodized black + opal diffuser
- 04 62 **Bianco + diffusore opale**
White + opal diffuser

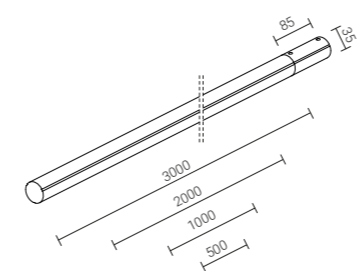

Codice Code	Lunghezza Length (mm)	LED Lumen	Product Lumen	Watt	Colour T (K)	CRI
Con un giunto lineare e diffusore in policarbonato opale. Doppia accensione 120° + 240°. Trasformatori e dimmer da ordinare separatamente / With one straight joint and diffuser in opal polycarbonate. Double switch 120° + 240°. Transformers and dimmers should be ordered separately.						
458-230059C	500	525 + 1050	293 + 586	5 + 10	2700	90
458-230059B	500	550 + 1100	307 + 614	5 + 10	3000	90
458-230109C	1000	1050 + 2100	586 + 1172	10 + 20	2700	90
458-230109B	1000	1100 + 2200	614 + 1228	10 + 20	3000	90
458-230209C	2000	2100 + 4200	1172 + 2344	20 + 40	2700	90
458-230209B	2000	2200 + 4400	1228 + 2456	20 + 40	3000	90
458-230309C	3000	3150 + 6300	1758 + 3517	30 + 60	2700	90
458-230309B	3000	3300 + 6600	1842 + 3684	30 + 60	3000	90

48Vbc



Per accessori vedi pag. 33. Per trasformatori e dimmer vedi pag. 35
For accessories see page 33. For transformers and dimmers see page 35

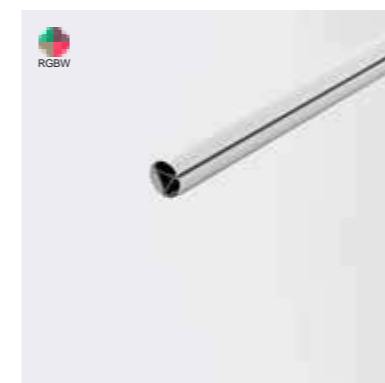

- 12 62 **Nero anodizzato + diffusore opale**
Anodized black + opal diffuser
- 04 62 **Bianco + diffusore opale**
White + opal diffuser

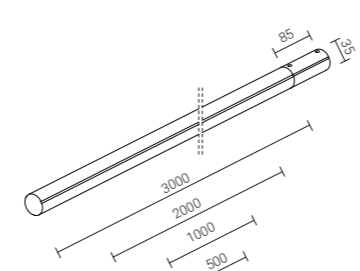

Codice Code	Lunghezza Length (mm)	LED Lumen	Product Lumen	Watt	Colour T (K)	CRI
Con un giunto lineare e diffusore in policarbonato opale. Singola accensione 360° - RGBW With one straight joint and diffuser in opal polycarbonate. Single switch 360° - RGBW						
478-13005EE	500	1161	649	15	RGBW 2700	90
478-13010EE	1000	2322	1300	30	RGBW 2700	90
478-13020EE	2000	4644	2601	60	RGBW 2700	90
478-13030EE	3000	6966	3891	90	RGBW 2700	90

48Vbc



Per accessori vedi pag. 33. Per trasformatori e dimmer vedi pag. 35
For accessories see page 33. For transformers and dimmers see page 35



Dettaglio giunto L bianco cod. 46-01-21
Mat white L joint detail code 46-01-21

35 Trentacinque

ELEMENTO LINEARE CONTINUO OFF / CONTINUOUS LINEAR ELEMENT OFF

Sistema lineare sospeso / Suspended linear system



Codice
Code

Lunghezza
Length (mm)

Per continuità con giunto lineare e cover in policarbonato nero
For continuity with one straight joint and cover in black polycarbonate

458-00010	1000
458-00020	2000

12 30 Nero anodizzato + cover nera
Anodized black + black cover

04 62 Bianco + diffusore opale
White + opal diffuser

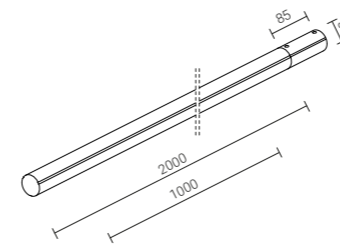

Cover fumé / Smoked diffuser

Quando Trentacinque (35) è spento, la cover fumé mantiene l'effetto di finitura nera dando l'impressione che l'alluminio e il diffusore siano un unico elemento continuo.

The smoked diffuser enables a continuous effect of black finish when the light is off, giving the impression that the metal parts and the diffuser are one and the same part.

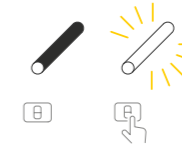

Accessori ottici intercambiabili / Replaceable optical accessories



46-11 (500 mm)
Diffusore fumé
Smoked diffuser



46-15 (1000 mm)
Diffusore fumé
Smoked diffuser



46-17 (2000 mm)
Diffusore fumé
Smoked diffuser



46-09 (3000 mm)
Diffusore fumé
Smoked diffuser

Accessori su richiesta / Accessories on demand

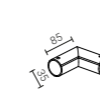

46-01
Giunto L
L joint

21 Bianco mat
Mat white
16 Nero
Black



46-02
Giunto flessibile
Flexible joint

21 Bianco mat
Mat white
16 Nero
Black



46-18
Giunto a L con cavo alimentatore
L joint with power cable

21 Bianco mat
Mat white
16 Nero
Black



46-05-00 (3000 mm)
Kit di sospensione
Suspension kit

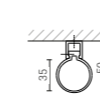

46-13 (3 pz / 3 pcs)
Kit di montaggio parete/soffitto
Kit for wall/ceiling mounting

21 Bianco mat
Mat white
16 Nero
Black



46-12
Rosone
Canopy

21 Bianco mat
Mat white
16 Nero
Black



Codice Code	Lunghezza Length (mm)
6447-20	2000
6447-30	3000

62 Nero anodizzato + diffusore opale
Anodized black + opal diffuser

04 62 Bianco + diffusore opale
White + opal diffuser



Equipaggiabile con proiettori 48V_{bc}, vedi pag. 129
It can be equipped with 48V_{bc} track lights, see page 129

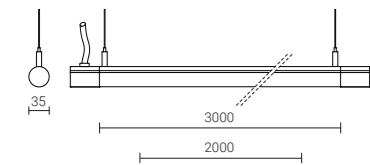

Accessori 35 Track / 35 Track accessories

<p>6490-10 Alimentazione destra Right live-end</p> <p>31 Bianco White</p> <p>30 Nero Black</p>	<p>6490-11 Alimentazione sinistra Left live-end</p> <p>31 Bianco White</p> <p>30 Nero Black</p>	<p>6491-00 Alimentazione centrale Central connector</p> <p>31 Bianco White</p> <p>30 Nero Black</p>	<p>6492-00 Giunto lineare elettrico Straight electric joint</p> <p>31 Bianco White</p> <p>30 Nero Black</p>
<p>6493-10 Giunto lineare meccanico Straight mechanical joint</p> <p>31 Bianco White</p> <p>30 Nero Black</p>	<p>6494-10 Giunto a L interno Inside L joint</p> <p>31 Bianco White</p> <p>30 Nero Black</p>	<p>6494-11 Giunto a L esterno Outside L joint</p> <p>31 Bianco White</p> <p>30 Nero Black</p>	<p>6495-00 Giunto flessibile Flexible joint</p> <p>31 Bianco White</p> <p>30 Nero Black</p>
<p>6496-00 (3000 mm) Kit di sospensione con anello, cavo e bloccacavo / Suspension kit with ring, wire and wire lock</p> <p>21 Bianco mat Mat white</p> <p>16 Nero Black</p>	<p>6497-00 (1000 mm) Kit di sospensione con anello rigido e tige rigida / Suspension kit with stiff ring and stiff rod</p> <p>21 Bianco mat Mat white</p> <p>16 Nero Black</p>	<p>6498-00 (1000 mm) Copertura binario Track cover</p> <p>31 Bianco White</p> <p>30 Nero Black</p>	<p>6499-00 Chiusura Dead end</p> <p>31 Bianco White</p> <p>30 Nero Black</p>
<p>6500-00 Giunto meccanico di collegamento 35/35 Track Mechanical connection joint 35/35 Track</p> <p>21 Bianco mat Mat white</p> <p>16 Nero Black</p>	<p>6501-00 Giunto meccanico di collegamento a L 35/35 Track Mechanical connection L joint 35/35 Track</p> <p>21 Bianco mat Mat white</p> <p>16 Nero Black</p>	<p>93-WB948-2520A-30 (3000 mm) Kit striplata cablata 48V Wired striplated kit 48V 25W/m 2585lm/m 3000K</p>	<p>93-WC948-2520A-30 (3000 mm) Kit striplata cablata 48V Wired striplated kit 48V 25W/m 2450lm/m 2700K</p>

Accessori ottici intercambiabili / Replaceable optical accessories

<p>46-17 (2000 mm) Diffusore fumé Smoked diffuser</p>	<p>46-09 (3000 mm) Diffusore fumé Smoked diffuser</p>
--	--

ELEMENTO LINEARE MASTER / MASTER LINEAR ELEMENT
ELEMENTO LINEARE CONTINUO / CONTINUOUS LINEAR ELEMENT

Trasformatori da ordinare separatamente
Transformers should be ordered separately

81-09000 48V_{bc}
Trasformatore PWM per uso remoto - 100W
PWM transformer for remote use - 100W

81-09001 48V_{bc}
Trasformatore PWM per uso remoto - 200W
PWM transformer for remote use - 200W

Dimmer da ordinare separatamente
Dimmers should be ordered separately

81-90089 Dimmer Casambi Bluetooth
4 canali / 4 channels

81-90123 Dimmer PWM

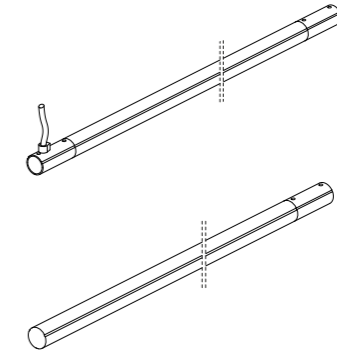

35 Track

Trasformatori da ordinare separatamente
Transformers should be ordered separately

81-09000 48V_{bc}
Trasformatore PWM per uso remoto - 100W
PWM transformer for remote use - 100W

81-09001 48V_{bc}
Trasformatore PWM per uso remoto - 200W
PWM transformer for remote use - 200W

81-90122 48V_{bc}
Trasformatore PWM per uso remoto - 300W
PWM transformer for remote use - 300W

6465-03-31 48V_{bc}
Trasformatore DALI per uso remoto - 150W
DALI transformer for remote use - 150W

Dimmer e controller da ordinare separatamente
Dimmer e controllers should be ordered separately

81-90089 Dimmer Casambi Bluetooth
4 canali / 4 channels

81-90123 Dimmer PWM

81-90124 Dimmer DALI

81-90128 Controller DALI Bluetooth



Schemi di dimmerazione
scaricabili dal sito
Dimming schemes can be
downloaded from the web site

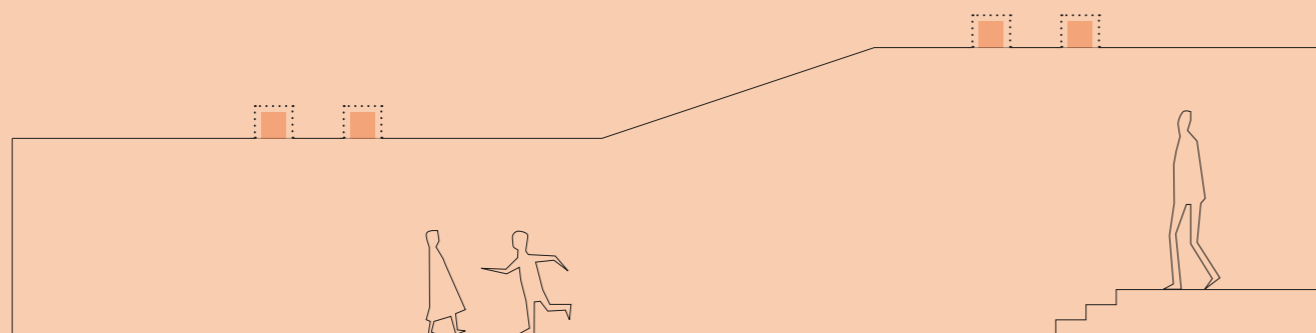

Protagonisti discreti: l'essenziale invisibile

Discreet protagonists: the invisible essential

^{ITA} Il controsoffitto ospita il corpo degli apparecchi celandone la presenza. Quando sono spenti diventano incredibilmente discreti, mentre quando sono accesi se ne avverte l'esistenza in funzione del fascio luminoso.

Gli incassi diffondono luce generale o d'accento, ma sempre ad alto rendimento luminoso. Esprimono valori di luminanza contenuti e livelli di abbagliamento estremamente bassi, grazie a ottiche arretrate e a un'ampia gamma di accessori.

^{EN} The false ceiling holds the body of the fittings, hiding their presence. When they are turned off, they become incredibly discreet. When they are turned on, they show themselves through the light beam.

The downlights spread general or accent light, keeping high luminous efficiency. The low luminance is combined with extremely low glare levels, thanks to the deeply recessed optics and a wide range of accessories.



Puzzle Bar – Hamburg (Lighting Design: Notholt Lighting Design)
Perfetto-IN 90 Dim to Warm

Soluzioni per il controllo della luce, a portata di mano

Solutions for lighting control, at your fingertips

^{ITA} La tecnologia Dim to Warm consente di gestire la temperatura di colore degli apparecchi, ottenendo variazioni graduali delle tonalità calde della luce, da 2700K a 1800K, attraverso la regolazione dell'intensità luminosa. La resa cromatica rimane costante a qualunque livello di regolazione luminosa. Con il diminuire dell'intensità luminosa, la luce diventerà di tonalità più calda. Grazie a questa tecnologia si possono creare infinite atmosfere luminose, ricreando il piacevole calore di una lampada ad incandescenza, ma con bassi consumi e migliori prestazioni tipiche dei LED. Dim to Warm consente una maggiore scelta in termini di uniformità progettuale e di design. Disponibile anche su apparecchi con lenti a fascio stretto, per creare effetti di luce drammatica in contesti hospitality e residenziali. Dim to Warm richiede l'utilizzo di sistemi di controllo 1-10V o DALI.

^{EN} Dim to Warm technology allows control of color temperature through the regulation of the luminous intensity, providing smooth variations of warm light tones, from 2700K to 1800K. As the luminous intensity of the light source goes down, the light becomes warmer, mimicking the natural warmth of an incandescent lamp, although with the low power consumption and better performance of LED. The color rendering remains constant, independent from the level of dimming. Dim to Warm technology allows a wider choice in terms of project and design uniformity. Available for luminaires with small beam lenses, to get dramatic light effects in hospitality and residential spaces. Dim to Warm requires the use of 1-10V or DALI control systems.



Features

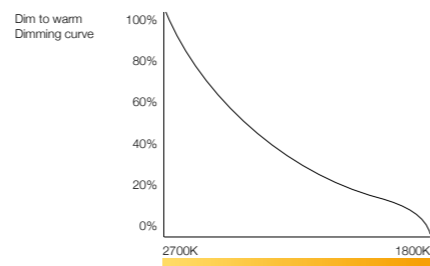

Effetto luminoso naturale / Natural lighting effect
 Illuminazione di alta qualità / High quality light
 Mantenimento della resa cromatica / Consistency of colour rendering
 Semplicità di utilizzo / User friendly



Dimming 10% – 1800K



Dimming 50% – 2200K



Dimming 100% – 2700K

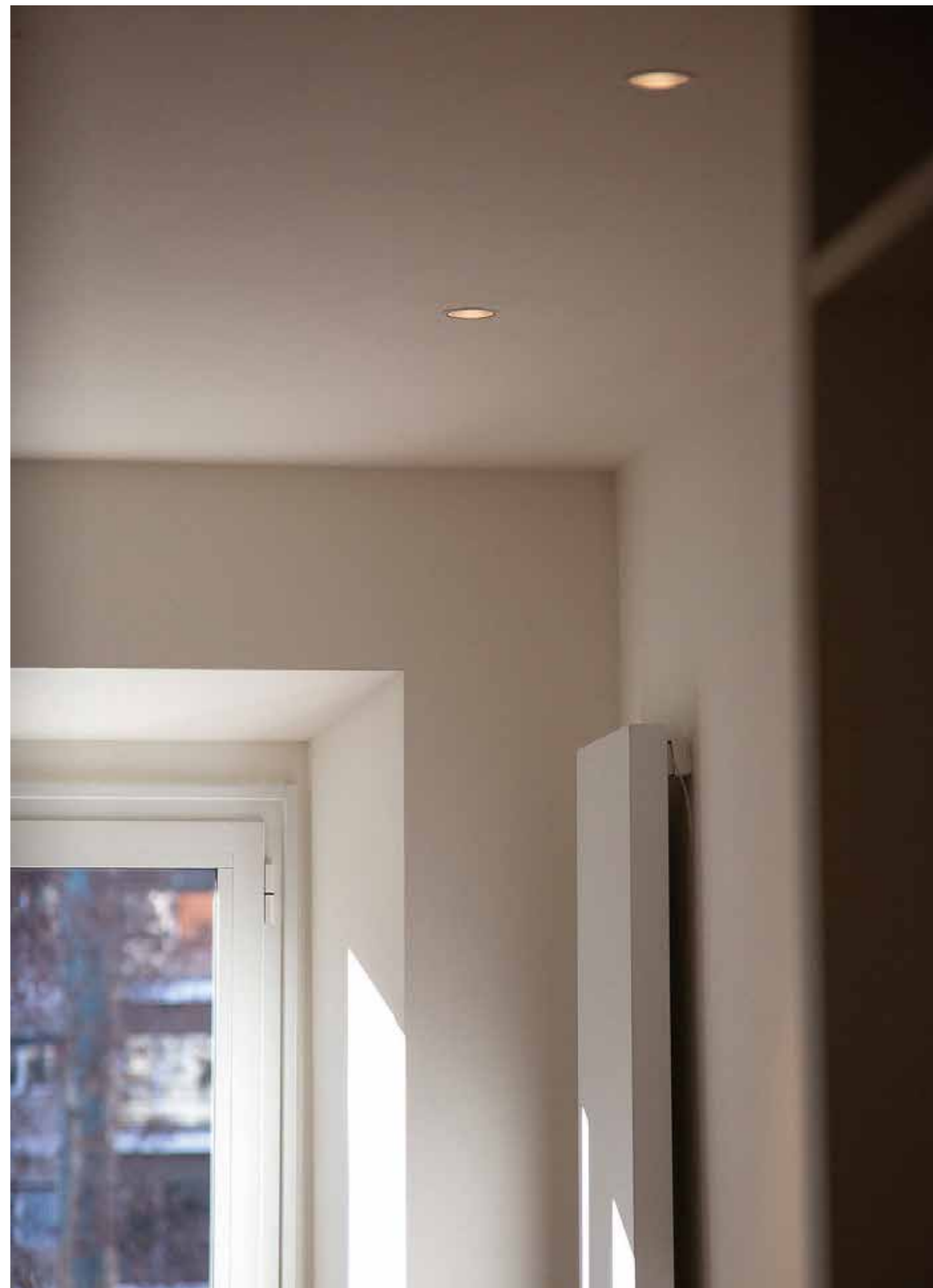

Perfetto-IN 70



^{ITA} Grazie alle dimensioni ridotte gli incassi Aria sono apparecchi impercettibili, ma performanti. Invisibili agli occhi, ma incredibilmente presenti negli ambienti dove vengono inseriti, grazie alla loro luce puntuale e morbida. Sono disponibili con dimensioni e forme differenti, per una massima libertà di progettazione.

^{EN} Thanks to their small size, Aria downlights are imperceptible but performing devices. They are almost invisible to the eyes but incredibly present in the spaces where they are, thanks to their punctual and soft light. They are available in different sizes and shapes for maximum design freedom.

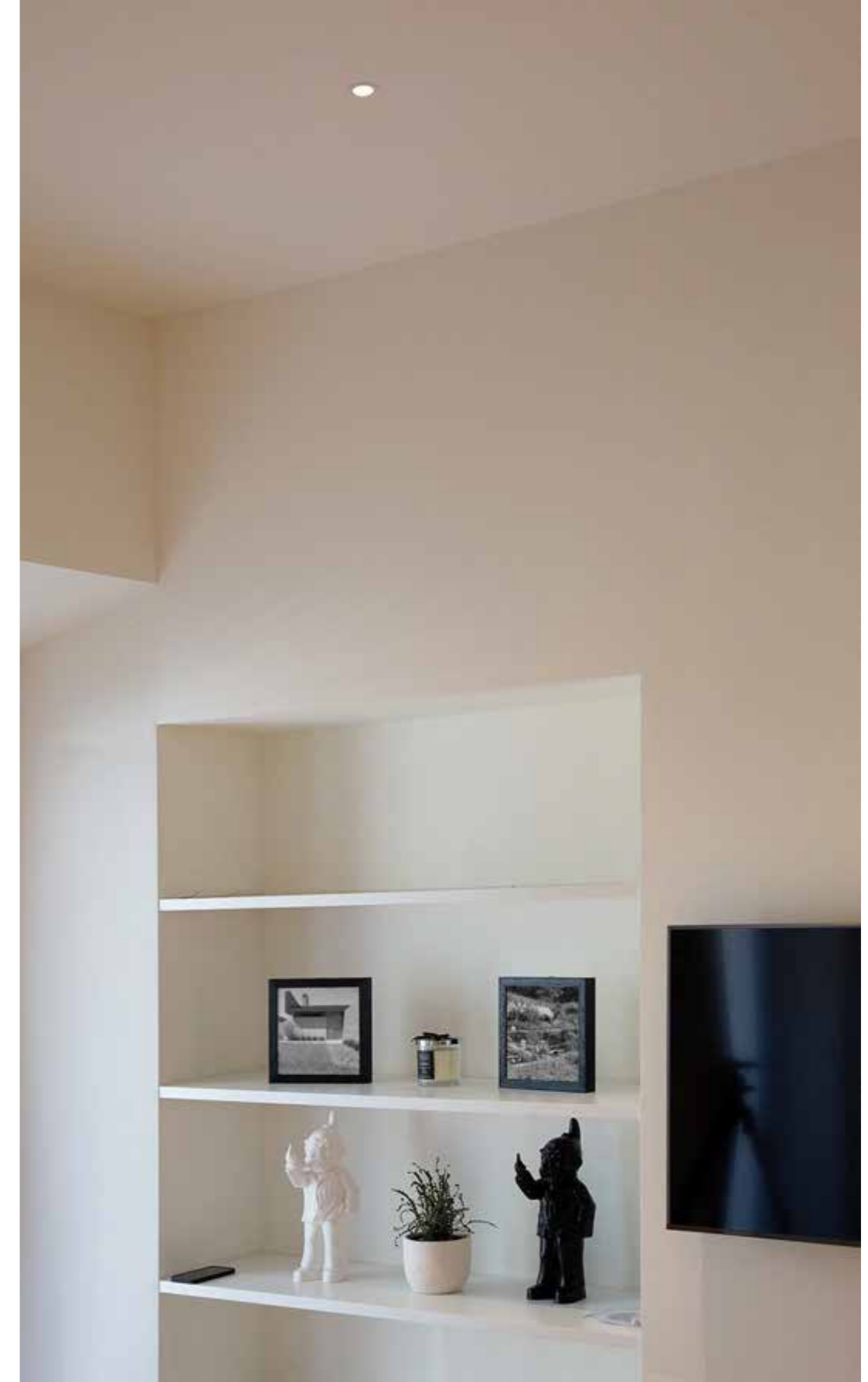



^{ITA} Minirooler-IN, incasso con 5 o 15 lenti in PMMA: la luce è al servizio dello spazio, a sottolineare forme, linee e funzioni. Mix perfetto tra design e funzionalità, offre proporzioni piacevoli insieme ad un'estetica contemporanea, ideale per soluzioni di interior design che prevedono minimo impatto visivo e controllo dell'abbagliamento.

^{EN} Minirooler-IN, downlight with 5 or 15 PMMA lenses: light is at service of the space, to emphasize forms, lines, and functions. A perfect mix of design and functionality, it offers pleasant proportions together with a contemporary aesthetic, ideal for all interior design solutions that require minimal visual impact and glare control.



Villa Mirella – Ruta di Camogli
(Interior & Lighting Design: SLAM Architects)

Distinctive Uniqueness

^{ITA} Gli incassi Aria sono progettati per sorgenti LED di ultima generazione e disponibili con diverse temperature di colore. Disponibili con numerose ottiche, per differenti fasci di luce, in unione a dispositivi ottici per un elevato comfort visivo. Sono previste versioni fisse, orientabili o wall washer, per una moltitudine di effetti di luce differenti.

^{EN} Aria downlights feature the latest LED sources and are available with different color temperatures. They provide numerous optics for numerous light beams and optical devices for a high visual comfort. Fixed, adjustable, or wall washer versions are available for a multitude of different light effects.





Minimo ingombro, massima resa. Anche IP



Small footprint, maximum yield. IP rated, too

^{ITA} Parte della gamma degli incassi Aria è sviluppata con alti gradi IP per far sì che i prodotti, oltre a risultare affidabili e resistenti, possano essere integrati anche in spazi con elevati livelli di umidità (bagni, docce, spa) ed aumentando quindi le possibilità di applicazione.

^{EN} Part of the Aria downlights range is developed with high IP protection ratings. The fittings are reliable and resistant and can be installed into spaces with high levels of humidity (bathrooms, showers, spas). For many more possibilities of application.



Luce flessibile, dove serve

Flexible light, where needed

^{ITA} Kardan-TL è ideale per ambienti espositivi e ovunque siano richieste luci d'accento, come vetrine, musei, gallerie d'arte. Caratterizzato da una o due fonti luminose orientabili e indipendenti fra loro, senza cornice di finitura è facilmente integrabile in ogni tipologia di arredo grazie alle sue linee essenziali e all'ampia gamma di accessori ottici a corredo.

^{EN} Kardan-TL is ideal for exhibition environments and wherever accent lighting is required, such as shop windows, museums, and art galleries. Characterized by one or two adjustable and independent light sources, without a finishing frame, it can be easily integrated into any architecture thanks to its essential lines and the wide range of optical accessories supplied.

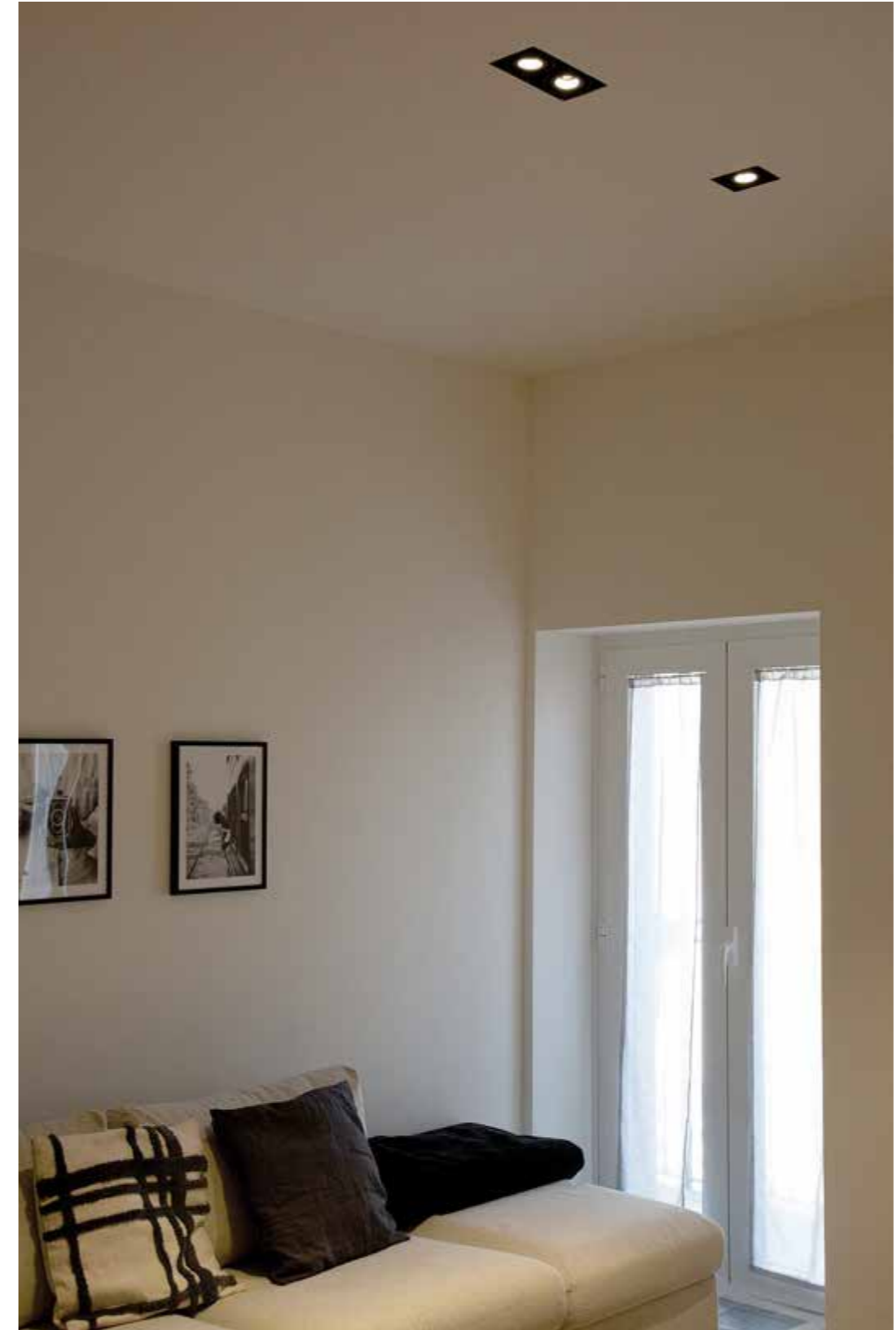



Products	Pages
Minirooler-IN	52, 53
Minirooler-TL	54, 55
Perfetto-IN 40	56
Perfetto-IN 50 / Perfetto-IN 50 IP65	57
Perfetto-IN 60	58
Perfetto-IN 60 IP65/20	59
Perfetto-IN 70	60
Perfetto-IN 70 Wall Washer	61
Perfetto-IN 80	62, 63
Perfetto-IN 90	64
Perfetto-IN 90 IP66	65, 66
RA 4 / RA 7	68
RA 8 L Dixit LED / RA 8 Dixit LED	69
RA 8 L IP65 Dixit LED / RA 8 IP65 Dixit LED	70

Products	Pages
RA 8 Q Dixit LED	71
RA 8 L TL Dixit LED / RA 8 TL Dixit LED	72
RA 8 Soft Dixit LED	73
RA 8 tiltable Dixit LED / RA 8 IP66 tiltable Dixit LED	74
RA 11 Dixit LED	75
RA 11 Q Dixit LED	76
RA 11 TL Dixit LED	77
RA 11 Soft Dixit LED	78
RA 11 tiltable Dixit LED	79
RA 14 Dixit LED	81
RA 16 / RA 17 Dixit LED	82
RA 20 Dixit LED / RA 23SP Dixit LED	83
Kardan-IN	84
Kardan-TL	85

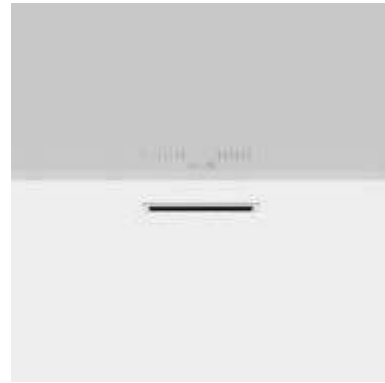

21 Bianco mat
Mat white

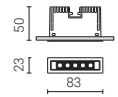

Longitudinale
Longitudinal

Codice Code	LED Lumen	Product Lumen	Watt	mA	Colour T (K)	CRI	Fascio Beam
Con cornice e 5 microlenti in PMMA, per applicazione a incasso With frame and 5 PMMA microlenses, for recessed application							
272-019BZN	550	446	5,2	350	3000	90	12°
	750	608	7,5	500	3000	90	12°
272-019BYN	550	380	5,2	350	3000	90	20°
	750	518	7,5	500	3000	90	20°
272-019BVN	550	440	5,2	350	3000	90	50°
	750	600	7,5	500	3000	90	50°
272-019BQN	550	380	5,2	350	3000	90	14° + 41° Longitudinale / Longitudinal
	750	518	7,5	500	3000	90	14° + 41° Longitudinale / Longitudinal
272-019CZN	550	446	5,2	350	2700	90	12°
	750	608	7,5	500	2700	90	12°
272-019CYN	550	380	5,2	350	2700	90	20°
	750	518	7,5	500	2700	90	20°
272-019CVN	550	440	5,2	350	2700	90	50°
	750	600	7,5	500	2700	90	50°
272-019CQN	550	380	5,2	350	2700	90	14° + 41° Longitudinale / Longitudinal
	750	518	7,5	500	2700	90	14° + 41° Longitudinale / Longitudinal

Driver da ordinare separatamente, per installazione attraverso il foro d'incasso
Driver should be ordered separately, for installation through the recessed hole

- 81-04076 Output 350mA*
- 81-04078 Output 500mA*
- 81-04081 Output 500mA
Dimmerabile DALI / DALI dimmable
- 81-04084 Output 500mA
Dimmerabile 1-10V / 1-10V dimmable

* Per una corretta installazione, considerare una profondità di incasso a soffitto di H180 mm x L120 mm
For a correct installation, please consider a ceiling recessed depth of H180 mm x L120 mm

Driver da ordinare separatamente, per installazione in posizione remota
Driver should be ordered separately, for remote installation

- 81-02506 Output 350mA max 2 apparecchi / max 2 fittings
- 81-04003 Output 350mA max 3 apparecchi / max 3 fittings
Dimmerabile DALI, 1-10V, Push / DALI dimmable, 1-10V, Push
- 81-02472 Output 350mA
Regolabile sul taglio di fase / Dimmable on the mains
- 81-02517 Output 500mA max 2 apparecchi / max 2 fittings
- 81-04002 Output 500mA max 2 apparecchi / max 2 fittings
Dimmerabile DALI / DALI dimmable
- 81-04029 Output 500mA
Regolabile sul taglio di fase / Dimmable on the mains



21 Bianco mat
Mat white

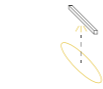
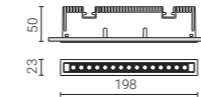

Longitudinale
Longitudinal

Codice Code	LED Lumen	Product Lumen	Watt	mA	Colour T (K)	CRI	Fascio Beam
Con cornice e 15 microlenti in PMMA, per applicazione a incasso With frame and 15 PMMA microlenses, for recessed application							
273-019BZN	1650	1337	15,5	350	3000	90	12°
	1800	1458	17,5	400	3000	90	12°
273-019BYN	1650	1139	15,5	350	3000	90	20°
	1800	1242	17,5	400	3000	90	20°
273-019BVN	1650	1320	15,5	350	3000	90	50°
	1800	1440	17,5	400	3000	90	50°
273-019BQN	1650	1139	15,5	350	3000	90	14° + 41° Longitudinale / Longitudinal
	1800	1242	17,5	400	3000	90	14° + 41° Longitudinale / Longitudinal
273-019CZN	1650	1337	15,5	350	2700	90	12°
	1800	1458	17,5	400	2700	90	12°
273-019CYN	1650	1139	15,5	350	2700	90	20°
	1800	1242	17,5	400	2700	90	20°
273-019CVN	1650	1320	15,5	350	2700	90	50°
	1800	1440	17,5	400	2700	90	50°
273-019CQN	1650	1139	15,5	350	2700	90	14° + 41° Longitudinale / Longitudinal
	1800	1242	17,5	400	2700	90	14° + 41° Longitudinale / Longitudinal

Driver da ordinare separatamente, per installazione attraverso il foro d'incasso
Driver should be ordered separately, for installation through the recessed hole

- 81-04076 Output 350mA*
- 81-04079 Output 350mA
Dimmerabile DALI / DALI dimmable
- 81-04082 Output 350mA
Dimmerabile 1-10V / 1-10V dimmable
- 81-04077 Output 400mA*
- 81-04080 Output 400mA
Dimmerabile DALI / DALI dimmable
- 81-04083 Output 400mA
Dimmerabile 1-10V / 1-10V dimmable

* Per una corretta installazione, considerare una profondità di incasso a soffitto di H140 mm x L120 mm
For a correct installation, please consider a ceiling recessed depth of H140 mm x L120 mm

Driver da ordinare separatamente, per installazione in posizione remota
Driver should be ordered separately, for remote installation

- 81-02506 Output 350mA
- 81-04003 Output 350mA
Dimmerabile DALI, 1-10V, Push / DALI dimmable, 1-10V, Push
- 81-02464 Output 350mA
Regolabile sul taglio di fase / Dimmable on the mains
- 81-02571 Output 400mA
- 81-02565 Output 400mA
Dimmerabile DALI / DALI dimmable
- 81-04057 Output 400mA
Dimmerabile 1-10V / 1-10V dimmable



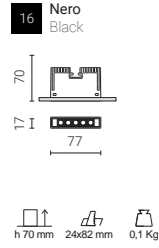
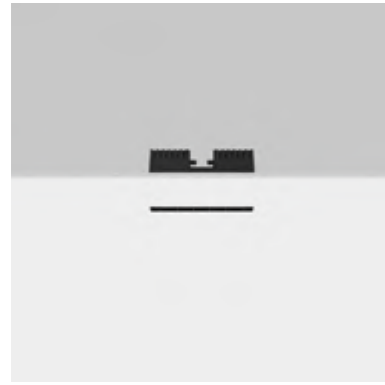

Codice Code	LED Lumen	Product Lumen	Watt	mA	Colour T (K)	CRI	Fascio Beam
Senza cornice, con 5 microlenti in PMMA, per applicazione a incasso Trimless, with 5 PMMA microlenses, for recessed application							
274-019BZN	550	446	5,2	350	3000	90	12°
	750	608	7,5	500	3000	90	12°
274-019BYN	550	380	5,2	350	3000	90	20°
	750	518	7,5	500	3000	90	20°
274-019BVN	550	440	5,2	350	3000	90	50°
	750	600	7,5	500	3000	90	50°
274-019BQN	550	380	5,2	350	3000	90	14° + 41° Longitudinale / Longitudinal
	750	518	7,5	500	3000	90	14° + 41° Longitudinale / Longitudinal
274-019CZN	550	446	5,2	350	2700	90	12°
	750	608	7,5	500	2700	90	12°
274-019CYN	550	380	5,2	350	2700	90	20°
	750	518	7,5	500	2700	90	20°
274-019CVN	550	440	5,2	350	2700	90	50°
	750	600	7,5	500	2700	90	50°
274-019CQN	550	380	5,2	350	2700	90	14° + 41° Longitudinale / Longitudinal
	750	518	7,5	500	2700	90	14° + 41° Longitudinale / Longitudinal

Driver da ordinare separatamente, per installazione attraverso il foro d'incasso
Driver should be ordered separately, for installation through the recessed hole

- 81-04076** Output 350mA*
- 81-04078** Output 500mA*
- 81-04081** Output 500mA
Dimmerabile DALI / DALI dimmable
- 81-04084** Output 500mA
Dimmerabile 1-10V / 1-10V dimmable

* Per una corretta installazione, considerare una profondità di incasso a soffitto di H180 mm x L120 mm
For a correct installation, please consider a ceiling recessed depth of H180 mm x L120 mm

Driver da ordinare separatamente, per installazione in posizione remota
Driver should be ordered separately, for remote installation

- 81-02506** Output 350mA max 2 apparecchi / max 2 fittings
- 81-04003** Output 350mA max 3 apparecchi / max 3 fittings
Dimmerabile DALI, 1-10V, Push / DALI dimmable, 1-10V, Push
- 81-02472** Output 350mA
Regolabile sul taglio di fase / Dimmable on the mains
- 81-02517** Output 500mA max 2 apparecchi / max 2 fittings
- 81-04002** Output 500mA max 2 apparecchi / max 2 fittings
Dimmerabile DALI / DALI dimmable
- 81-04029** Output 500mA
Regolabile sul taglio di fase / Dimmable on the mains

CE IP20

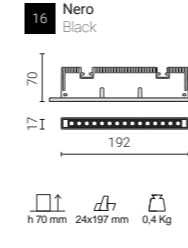
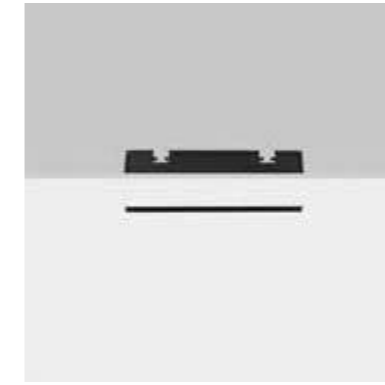

Codice Code	LED Lumen	Product Lumen	Watt	mA	Colour T (K)	CRI	Fascio Beam
Senza cornice con 15 microlenti in PMMA, per applicazione a incasso Trimless with 15 PMMA microlenses, for recessed application							
275-019BZN	1650	1337	15,5	350	3000	90	12°
	1800	1458	17,5	400	3000	90	12°
275-019BYN	1650	1139	15,5	350	3000	90	20°
	1800	1242	17,5	400	3000	90	20°
275-019BVN	1650	1320	15,5	350	3000	90	50°
	1800	1440	17,5	400	3000	90	50°
275-019BQN	1650	1139	15,5	350	3000	90	14° + 41° Longitudinale / Longitudinal
	1800	1242	17,5	400	3000	90	14° + 41° Longitudinale / Longitudinal
275-019CZN	1650	1337	15,5	350	2700	90	12°
	1800	1458	17,5	400	2700	90	12°
275-019CYN	1650	1139	15,5	350	2700	90	20°
	1800	1242	17,5	400	2700	90	20°
275-019CVN	1650	1320	15,5	350	2700	90	50°
	1800	1440	17,5	400	2700	90	50°
275-019CQN	1650	1139	15,5	350	2700	90	14° + 41° Longitudinale / Longitudinal
	1800	1242	17,5	400	2700	90	14° + 41° Longitudinale / Longitudinal

Driver da ordinare separatamente, per installazione attraverso il foro d'incasso
Driver should be ordered separately, for installation through the recessed hole

- 81-04076** Output 350mA*
- 81-04079** Output 350mA
Dimmerabile DALI / DALI dimmable
- 81-04082** Output 350mA
Dimmerabile 1-10V / 1-10V dimmable
- 81-04077** Output 400mA*
- 81-04080** Output 400mA
Dimmerabile DALI / DALI dimmable
- 81-04083** Output 400mA
Dimmerabile 1-10V / 1-10V dimmable

* Per una corretta installazione, considerare una profondità di incasso a soffitto di H140 mm x L120 mm
For a correct installation, please consider a ceiling recessed depth of H140 mm x L120 mm

Driver da ordinare separatamente, per installazione in posizione remota
Driver should be ordered separately, for remote installation

- 81-02506** Output 350mA
- 81-04003** Output 350mA
Dimmerabile DALI, 1-10V, Push / DALI dimmable, 1-10V, Push
- 81-02464** Output 350mA
Regolabile sul taglio di fase / Dimmable on the mains
- 81-02571** Output 400mA
- 81-02565** Output 400mA
Dimmerabile DALI / DALI dimmable
- 81-04057** Output 400mA
Dimmerabile 1-10V / 1-10V dimmable

CE IP20

PERFETTO - IN 40
CON LENTE / WITH LENS



Codice Code	LED Lumen	Product Lumen	Watt	mA	Colour T (K)	CRI	Fascio Beam
Fisso con lente non sostituibile e vetro zigrinato Fixed with not replaceable lens and prismatic spread lens							
254-219BN	150	127	2	500	3000	90	14°
	200	170	3	700	3000	90	14°
254-219CN	130	110	2	500	2700	90	14°
	180	153	3	700	2700	90	14°

Driver per installazione in posizione remota, da ordinare separatamente
Driver for remote installation, to be ordered separately

81-04019 Output 500mA (max 20W) - max 8 apparecchi / max 8 fittings
Corrente costante / Constant current

81-02531 Output 700mA (max 12W) - max 3 apparecchi / max 3 fittings
Corrente costante / Constant current

21 Bianco mat / Mat white 16 Nero / Black

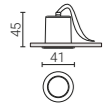

h 45 mm Ø 36 mm 0,1 Kg



IP43 IK07

PERFETTO - IN 50
CON LENTE / WITH LENS



Codice Code	LED Lumen	Product Lumen	Watt	mA	Colour T (K)	CRI	Fascio Beam
Fisso con lente in PMMA e schermo in termoplastico satinato Fixed with PMMA lens and frosted thermoplastic screen							
225-039BN	611	525	6	500	3000	90	21°
225-039BWN	611	525	6	500	3000	90	38°
225-039BRN	611	525	6	500	3000	90	15°+41°
225-039CN	579	498	6	500	2700	90	21°
225-039CWN	579	498	6	500	2700	90	38°
225-039CRN	579	498	6	500	2700	90	15°+41°

Driver da ordinare separatamente / Driver should be ordered separately

81-04029 Output 500mA
Regolabile sul taglio di fase / Dimmable on the mains

81-04026 Output 500mA
Dimmerabile DALI / DALI dimmable

21 Bianco mat / Mat white 16 Nero / Black

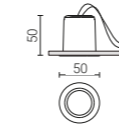

h 50 mm Ø 43 mm 0,1 Kg



IP43 IK08

PERFETTO - IN 50
IP65



Codice Code	LED Lumen	Product Lumen	Watt	mA	Colour T (K)	CRI	Fascio Beam
Fisso con schermo in termoplastico satinato Fixed with frosted thermoplastic screen							
225-129BVN	490	343	4,5	500	3000	90	54°
	650	455	6,5	700	3000	90	54°
225-129CVN	470	329	4,5	500	2700	90	54°
	620	434	6,5	700	2700	90	54°

Driver da ordinare separatamente / Driver should be ordered separately

81-04029 Output 500mA
Regolabile sul taglio di fase / Dimmable on the mains

81-04026 Output 500mA
Dimmerabile DALI / DALI dimmable

81-04027 Output 700mA
Regolabile sul taglio di fase / Dimmable on the mains

81-04028 Output 700mA* - max 4 apparecchi / max 4 fittings
Dimmerabile DALI / DALI dimmable

* Per una corretta installazione, considerare una profondità di incasso a soffitto di 200 mm
For a correct installation, please consider a ceiling recessed depth of 200 mm

21 Bianco mat / Mat white 16 Nero / Black

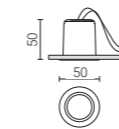

h 50 mm Ø 43 mm 0,1 Kg



IP65/20 IK08

Accessori ottici intercambiabili / Replaceable optical accessories

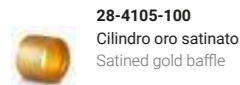

28-4105-100
Cilindro oro satinato
Satinated gold baffle

Accessori ottici intercambiabili solo per Perfetto - IN 50 con lente
Replaceable optical accessories only for Perfetto - IN 50 with lens

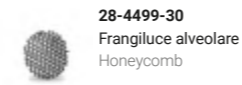

28-4499-30
Frangilucente alveolare
Honeycomb

PERFETTO - IN 60
CON LENTE / WITH LENS

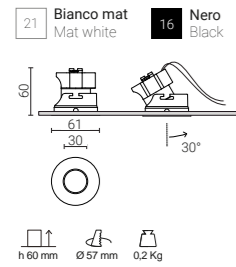

Codice Code	LED Lumen	Product Lumen	Watt	mA	Colour T (K)	CRI	Fascio Beam
Oscillante con lente in PMMA Tilttable with PMMA lens							
260-069BN	611	519	6	500	3000	90	21°
260-069BWN	611	519	6	500	3000	90	38°
260-069BRN	611	519	6	500	3000	90	15°+41°
260-069CN	579	492	6	500	2700	90	21°
260-069CWN	579	492	6	500	2700	90	38°
260-069CRN	579	492	6	500	2700	90	15°+41°
260-049MN	494*	420	5	300	1800-2700 Dim to Warm	90	21°
260-049MWN	494*	420	5	300	1800-2700 Dim to Warm	90	38°
260-049MRN	494*	420	5	300	1800-2700 Dim to Warm	90	15°+41°

*Valore riferito alla massima dimmerazione / Value referring to max dimming

Driver da ordinare separatamente / Driver should be ordered separately

- 81-04029** Output 500mA
Regolabile sul taglio di fase / Dimmable on the mains
- 81-04026** Output 500mA
Dimmerabile DALI / DALI dimmable
- 81-04075** Output 300mA
Regolabile sul taglio di fase / Dimmable on the mains
- 81-04074** Output 300mA
Dimmerabile DALI / DALI dimmable
- 81-04072** Output 300mA
Dimmerabile 1-10V / 1-10V dimmable



Accessori ottici intercambiabili / Replaceable optical accessories

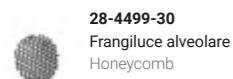

28-4499-30
Frangiluce alveolare
Honeycomb

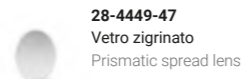

28-4449-47
Vetro zigrinato
Prismatic spread lens

PERFETTO - IN 60 IP65/20
CON LENTE / WITH LENS

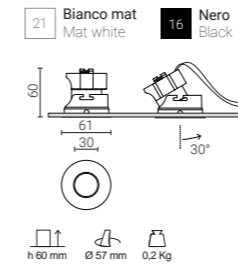

Codice Code	LED Lumen	Product Lumen	Watt	mA	Colour T (K)	CRI	Fascio Beam
Oscillante con lente in PMMA Tilttable with PMMA lens							
261-069BN	611	519	6	500	3000	90	21°
261-069BWN	611	519	6	500	3000	90	38°
261-069BRN	611	519	6	500	3000	90	15°+41°
261-069CN	579	492	6	500	2700	90	21°
261-069CWN	579	492	6	500	2700	90	38°
261-069CRN	579	492	6	500	2700	90	15°+41°

Driver da ordinare separatamente / Driver should be ordered separately

- 81-04029** Output 500mA
Regolabile sul taglio di fase / Dimmable on the mains
- 81-04026** Output 500mA
Dimmerabile DALI / DALI dimmable



Accessori ottici intercambiabili / Replaceable optical accessories

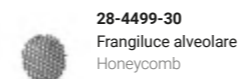

28-4499-30
Frangiluce alveolare
Honeycomb

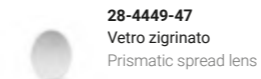

28-4449-47
Vetro zigrinato
Prismatic spread lens



21 Bianco mat / Mat white 16 Nero / Black

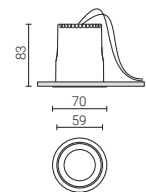

h 83 mm Ø 64 mm 0,3 Kg

Codice Code	LED Lumen	Product Lumen	Watt	mA	Colour T (K)	CRI	Fascio Beam
Fisso con schermo in termoplastico trasparente Fixed with clear thermoplastic screen							
262-039BNY	800	464	6	180	3000	90	21°
	1090	632	9	250	3000	90	21°
	1470	853	12	350	3000	90	21°
262-039BN	800	464	6	180	3000	90	38°
	1090	632	9	250	3000	90	38°
	1470	853	12	350	3000	90	38°
262-039BNW	800	464	6	180	3000	90	44°
	1090	632	9	250	3000	90	44°
	1470	853	12	350	3000	90	44°
262-039CNY	770	447	6	180	2700	90	21°
	1050	609	9	250	2700	90	21°
	1430	830	12	350	2700	90	21°
262-039CN	770	447	6	180	2700	90	38°
	1050	609	9	250	2700	90	38°
	1430	830	12	350	2700	90	38°
262-039CNW	770	447	6	180	2700	90	44°
	1050	609	9	250	2700	90	44°
	1430	830	12	350	2700	90	44°
262-049MN	1130*	656	12	350	1800-2700 Dim to Warm	90	38°

*Valore riferito alla massima dimmerazione / Value referring to max dimming

Driver da ordinare separatamente / Driver should be ordered separately

- 81-04023** Output 180mA
Regolabile sul taglio di fase e 1-10V
Dimmable on the mains and 1-10V
- 81-04009** Output 250mA
- 81-04010** Output 350mA
Regolabile sul taglio di fase (anche per Dim to Warm)
Dimmable on the mains (also for Dim to Warm)
- 81-04003** Output 350mA
Dimmerabile DALI (anche per Dim to Warm)
DALI dimmable (also for Dim to Warm)

CE, RoHS, Energy Star, IP43, IK08

Accessori ottici intercambiabili / Replaceable optical accessories



28-4039-100
Cilindro oro satinato
Satined gold baffle



28-4039-31
Cilindro bianco
White baffle



28-4208-30
Frangilucente alveolare
Honeycomb



28-4065-47
Vetro zigrinato (utilizzare al posto dello schermo di chiusura in dotazione)
Prismatic spread lens (to be used only instead of included closing screen)



28-4065-61
Vetro sabbaiato (utilizzare al posto dello schermo di chiusura in dotazione)
Frosted glass (to be used only instead of included closing screen)



28-4065-103
Vetro ellittico (utilizzare al posto dello schermo di chiusura in dotazione)
Elliptical spread lens (to be used only instead of included closing screen)

PERFETTO - IN 70
WALL WASHER



21 Bianco mat / Mat white 16 Nero / Black

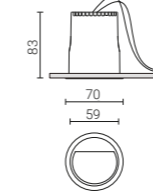

h 83 mm Ø 64 mm 0,3 Kg

Codice Code	LED Lumen	Product Lumen	Watt	mA	Colour T (K)	CRI	Fascio Beam
Fisso con lente effetto wall washer Fixed with wall washer lens							
262-019BNWW	800	720	6	180	3000	90	Wall Washer
	1090	981	9	250	3000	90	Wall Washer
262-019CNWW	770	693	6	180	2700	90	Wall Washer
	1050	945	9	250	2700	90	Wall Washer

Driver da ordinare separatamente / Driver should be ordered separately

- 81-04023** Output 180mA
Regolabile sul taglio di fase e 1-10V
Dimmable on the mains and 1-10V
- 81-04009** Output 250mA
- 81-04003-250** Output 250mA
Dimmerabile DALI / DALI dimmable

CE, RoHS, Energy Star, IP43

PERFETTO - IN 80
CON LENTE / WITH LENS



21 Bianco mat / Mat white
16 Nero / Black

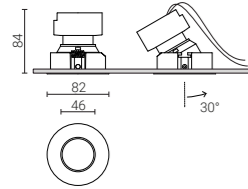

h 85 mm
Ø 75 mm
0,4 Kg

Codice Code	LED Lumen	Product Lumen	Watt	mA	Colour T (K)	CRI	Fascio Beam
Oscillante con lente in PMMA e schermo in termoplastico satinato Tilttable with PMMA lens and frosted thermoplastic screen							
268-069BN	611	525	6	500	3000	90	21°
	809	696	8,7	700	3000	90	21°
268-069BWN	611	525	6	500	3000	90	38°
	809	696	8,7	700	3000	90	38°
268-069CN	579	498	6	500	2700	90	21°
	766	659	8,7	700	2700	90	21°
268-069CWN	579	498	6	500	2700	90	38°
	766	659	8,7	700	2700	90	38°

Driver da ordinare separatamente / Driver should be ordered separately

- 81-04029** Output 500mA
Regolabile sul taglio di fase / Dimmable on the mains
- 81-04002** Output 500mA
Dimmerabile DALI / DALI dimmable
- 81-04027** Output 700mA
Regolabile sul taglio di fase / Dimmable on the mains
- 81-04028** Output 700mA*
Dimmerabile DALI / DALI dimmable

*Per una corretta installazione, considerare una profondità di incasso a soffitto di 200mm.
For a correct installation, please consider a ceiling recessed depth of 200 mm.

CE, RoHS, Energy Star, DALI, 850°, IP43, IK08

Accessori ottici intercambiabili / Replaceable optical accessories

28-4163-30
Frangilucente alveolare
Honeycomb

PERFETTO - IN 80



21 Bianco mat / Mat white
16 Nero / Black

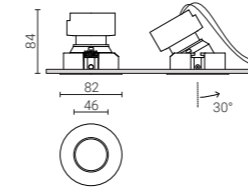

h 85 mm
Ø 75 mm
0,4 Kg

Codice Code	LED Lumen	Product Lumen	Watt	mA	Colour T (K)	CRI	Fascio Beam
Oscillante / Tilttable							
268-039BYN	800	448	6	180	3000	90	21°
	1090	611	9	250	3000	90	21°
	1470	824	12	350	3000	90	21°
	1917	1074	18	500	3000	90	21°
268-039BN	800	448	6	180	3000	90	38°
	1090	611	9	250	3000	90	38°
	1470	824	12	350	3000	90	38°
	1917	1074	18	500	3000	90	38°
268-039CYN	770	432	6	180	2700	90	21°
	1050	588	9	250	2700	90	21°
	1430	801	12	350	2700	90	21°
	1850	1036	18	500	2700	90	21°
268-039CN	770	432	6	180	2700	90	38°
	1050	588	9	250	2700	90	38°
	1430	801	12	350	2700	90	38°
	1850	1036	18	500	2700	90	38°

Driver da ordinare separatamente / Driver should be ordered separately

- 81-04023** Output 180mA
Regolabile sul taglio di fase e 1-10V
Dimmable on the mains and 1-10V
- 81-04009** Output 250mA
- 81-04010** Output 350mA
Regolabile sul taglio di fase / Dimmable on the mains
- 81-04003** Output 350mA
Dimmerabile DALI / DALI dimmable
- 81-04011** Output 500mA
- 81-04002** Output 500mA
Dimmerabile DALI / DALI dimmable

CE, RoHS, Energy Star, DALI, 850°, IP20, IK08

Accessori ottici intercambiabili / Replaceable optical accessories

28-4163-30
Frangilucente alveolare
Honeycomb

28-3905-47
Schermo di chiusura in termoplastico trasparente
Closing screen in clear thermoplastic material

28-4074-47
Vetro zigrinato
Prismatic spread lens

28-4073-61
Vetro sabbiato
Frosted glass

28-4073-103
Vetro ellittico
Elliptical spread lens

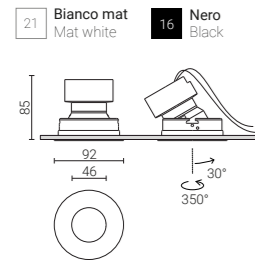

Codice Code	LED Lumen	Product Lumen	Watt	mA	Colour T (K)	CRI	Fascio Beam
Oscillante e rotante / Rotatable and tiltable							
263-039BNY	800	448	6	180	3000	90	21°
	1090	611	9	250	3000	90	21°
	1470	824	12	350	3000	90	21°
	1917	1074	18	500	3000	90	21°
263-039BN	800	448	6	180	3000	90	38°
	1090	611	9	250	3000	90	38°
	1470	824	12	350	3000	90	38°
	1917	1074	18	500	3000	90	38°
263-039CNY	770	432	6	180	2700	90	21°
	1050	588	9	250	2700	90	21°
	1430	801	12	350	2700	90	21°
	1850	1036	18	500	2700	90	21°
263-039CN	770	432	6	180	2700	90	38°
	1050	588	9	250	2700	90	38°
	1430	801	12	350	2700	90	38°
	1850	1036	18	500	2700	90	38°

263-049MN 1130* 633 12 350 1800-2700 Dim to Warm 90 38°
 *Valore riferito alla massima dimmerazione / Value referring to max dimming

Driver da ordinare separatamente / Driver should be ordered separately

- 81-04023** Output 180mA
Regolabile sul taglio di fase e 1-10V
Dimmable on the mains and 1-10V
- 81-04009** Output 250mA
- 81-04010** Output 350mA
Regolabile sul taglio di fase (anche per Dim to Warm)
Dimmable on the mains (also for Dim to Warm)
- 81-04003** Output 350mA
Dimmerabile DALI (anche per Dim to Warm)
DALI dimmable (also for Dim to Warm)
- 81-04011** Output 500mA
- 81-04002** Output 500mA
Dimmerabile DALI / DALI dimmable

CE, RoHS, ENEC, IP20, IK08

Accessori ottici intercambiabili / Replaceable optical accessories

- 28-4163-30** Frangiluce alveolare Honeycomb
- 28-3905-47** Schermo di chiusura in termoplastico trasparente
Closing screen in clear thermoplastic material
- 28-4074-47** Vetro zigrinato Prismatic spread lens
- 28-4073-61** Vetro sabbiato Frosted glass
- 28-4073-103** Vetro ellittico Elliptical spread lens

Accessori su richiesta / Accessories on demand

- 28-4318-21** Cornice quadra bianco mat
Mat white square frame
Dimensions: 92x112 mm, Ø 100 mm
- 28-4181-21** Cornice tonda doppia bianco mat
Mat white twin round frame
Dimensions: 2x Ø 100 mm, 224 mm diameter

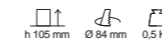
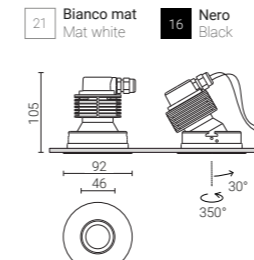

Codice Code	LED Lumen	Product Lumen	Watt	mA	Colour T (K)	CRI	Fascio Beam
Oscillante e rotante con lente in PMMA e schermo in termoplastico satinato Rotatable and tiltable with PMMA lens and frosted thermoplastic screen							
266-069BN	611	525	6	500	3000	90	21°
	809	696	8,7	700	3000	90	21°
266-069BWN	611	525	6	500	3000	90	38°
	809	696	8,7	700	3000	90	38°
266-069CN	579	498	6	500	2700	90	21°
	766	659	8,7	700	2700	90	21°
266-069CWN	579	498	6	500	2700	90	38°
	766	659	8,7	700	2700	90	38°

Driver da ordinare separatamente / Driver should be ordered separately

- 81-04040** Output 500mA (IP68)
- 81-04029** Output 500mA
Regolabile sul taglio di fase / Dimmable on the mains
- 81-04026** Output 500mA
Dimmerabile DALI / DALI dimmable
- 81-04032** Output 700mA (IP68)
- 81-04034** Output 700mA (IP68)
Dimmerabile DALI / DALI dimmable
- 81-04027** Output 700mA
Regolabile sul taglio di fase / Dimmable on the mains
- 81-04028** Output 700mA
Dimmerabile DALI / DALI dimmable

CE, RoHS, ENEC, IP66, IK08

Accessori ottici intercambiabili / Replaceable optical accessories

- 28-4163-30** Frangiluce alveolare Honeycomb

Accessori su richiesta / Accessories on demand

- 84108** Connettore stagno
Rated cable connector
- 28-4318-21** Cornice quadra bianco mat
Mat white square frame
Dimensions: 92x112 mm, Ø 100 mm
- 28-4181-21** Cornice tonda doppia bianco mat
Mat white twin round frame
Dimensions: 2x Ø 100 mm, 224 mm diameter



73 Bianco/ Deflettore nero
White/ Black baffle

16 Nero
Black

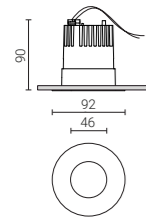

h 90 mm
Ø 92 mm
0,5 Kg

Codice Code	LED Lumen	Product Lumen	Watt	mA	Colour T (K)	CRI	Fascio Beam
Fisso / Fixed							
265-250BNW	800	448	6	180	3000	90	38°
	1090	611	9	250	3000	90	38°
	1470	824	12	350	3000	90	38°
265-250CNW	770	432	6	180	2700	90	38°
	1050	588	9	250	2700	90	38°
	1430	801	12	350	2700	90	38°

Driver da ordinare separatamente / Driver should be ordered separately

- 81-04023** Output 180mA
Regolabile sul taglio di fase e 1-10V
Dimmable on the mains and 1-10V
- 81-04009** Output 250mA
- 81-04010** Output 350mA
Regolabile sul taglio di fase / Dimmable on the mains
- 81-04003** Output 350mA
Dimmerabile DALI / DALI dimmable

CE RoHS IP66/20 IK08

Accessori ottici intercambiabili / Replaceable optical accessories



28-4163-30
Frangilucente alveolare
Honeycomb



28-4190-47
Vetro zigrinato
Prismatic spread lens



28-4073-61
Vetro sabbiato
Frosted glass



28-4073-103
Vetro ellittico
Elliptical spread lens

Accessori su richiesta / Accessories on demand



84108
Connettore stagno
Rated cable connector



RA 4



21 Bianco mat
Mat white

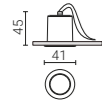

Codice Code	LED Lumen	Product Lumen	Watt	mA	Colour T (K)	CRI	Fascio Beam
252-200	540	320	4,6	500	3000	85	60°

Driver per installazione in posizione remota, da ordinare separatamente
Driver for remote installation, to be ordered separately

81-04019 Output 500mA (max 20W) - max 4 apparecchi / max 4 fittings
Corrente costante / Constant current

Driver per installazione attraverso il foro d'incasso, da ordinare separatamente
Driver for installation through the recessed hole, to be ordered separately

81-04031 Output 500mA* (max 14W) - max 4 apparecchi / max 4 fittings
Corrente costante / Constant current

*Per una corretta installazione, considerare una profondità di incasso a soffitto di 160mm.
For a correct installation, please consider a ceiling recessed depth of 160mm.



RA 7



21 Bianco mat
Mat white

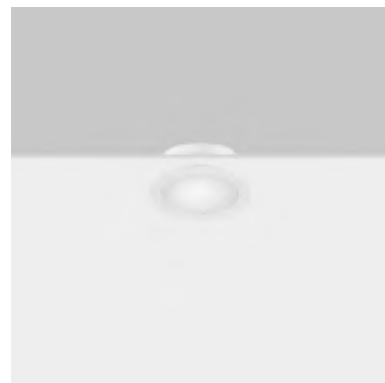

21 Bianco mat
Mat white

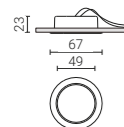

Codice Code	LED Lumen	Product Lumen	Watt	mA	Colour T (K)	CRI	Fascio Beam
-------------	-----------	---------------	------	----	--------------	-----	-------------

Con lente in PMMA / With PMMA lens

251-259BZN	453	-	4,1	350	3000	90	14°
	619	-	6	500	3000	90	14°

251-259BWN	453	-	4,1	350	3000	90	36°
	619	-	6	500	3000	90	36°

Driver da ordinare separatamente / Driver should be ordered separately

81-02408 Output 350mA

81-04013 Output 350mA
Dimmerabile DALI / DALI dimmable

81-04008 Output 500mA
Regolabile sul taglio di fase e 1-10V
Dimmable on the mains and 1-10V

81-04002 Output 500mA
Dimmerabile DALI / DALI dimmable

Codice Code	LED Lumen	Product Lumen	Watt	mA	Colour T (K)	CRI	Fascio Beam
-------------	-----------	---------------	------	----	--------------	-----	-------------

Schermo di chiusura in policarbonato opale / Closing screen in opal polycarbonate

251-200	540	378	4,6	500	3000	85	110°
----------------	-----	-----	-----	-----	------	----	------

Driver da ordinare separatamente / Driver to be ordered separately

81-04019 Output 500mA* (max 20W) - max 4 apparecchi / max 4 fittings
Corrente costante / Constant current

*Distanza max dal driver 30m
Max distance from driver 30m



RA 8 L DIXIT LED



21 Bianco mat
Mat white

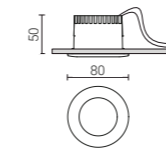

Codice Code	LED Lumen	Product Lumen	Watt	mA	Colour T (K)	CRI	Fascio Beam
238-239BN	550	501	5,5	350	3000	90	26°
	700	638	8,5	500	3000	90	26°
238-239AN	650	592	5,5	350	4000	90	26°
	800	729	8,5	500	4000	90	26°

Driver da ordinare separatamente / Driver should be ordered separately

81-04007 Output 350mA
Regolabile sul taglio di fase e 1-10V
Dimmable on the mains and 1-10V

81-04003 Output 350mA
Dimmerabile DALI / DALI dimmable

81-04008 Output 500mA
Regolabile sul taglio di fase e 1-10V
Dimmable on the mains and 1-10V

81-04002 Output 500mA
Dimmerabile DALI / DALI dimmable



RA 8 DIXIT LED



21 Bianco mat
Mat white

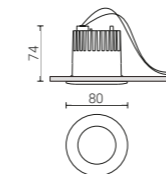

Codice Code	LED Lumen	Product Lumen	Watt	mA	Colour T (K)	CRI	Fascio Beam
238-250BN	1250	1096	9	250	3000	80	26°
	1650	1447	12	350	3000	80	26°
238-250AN	1300	1140	9	250	4000	80	26°
	1700	1491	12	350	4000	80	26°

Driver da ordinare separatamente / Driver should be ordered separately

81-04009 Output 250mA

81-04042 Output 250mA
Dimmerabile DALI / DALI dimmable

81-04010 Output 350mA
Regolabile sul taglio di fase / Dimmable on the mains

81-04003 Output 350mA
Dimmerabile DALI / DALI dimmable



Accessori ottici intercambiabili / Replaceable optical accessories

28-3868-51
Ottica professionale W
Professional optic device W
Fascio / Beam: 45°

28-3868-31
Ottica professionale XW
Professional optic device XW
Fascio / Beam: 65°

RA 8 L DIXIT LED IP65



73 Bianco / Deflettore nero
White / Black baffle

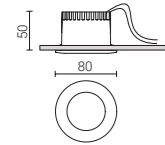

h 50 mm Ø 70 mm 0,4 Kg

Codice Code	LED Lumen	Product Lumen	Watt	mA	Colour T (K)	CRI	Fascio Beam
237-239BN	550	501	5,5	350	3000	90	26°
	700	638	8,5	500	3000	90	26°

Driver da ordinare separatamente / Driver should be ordered separately

81-04007	Output 350mA Regolabile sul taglio di fase e 1-10V Dimmable on the mains and 1-10V
81-04003	Output 350mA Dimmerabile DALI / DALI dimmable
81-04008	Output 500mA Regolabile sul taglio di fase e 1-10V Dimmable on the mains and 1-10V
81-04002	Output 500mA Dimmerabile DALI / DALI dimmable

CE ENEC IP65/20 IK08 UGR¹⁵

RA 8 DIXIT LED IP65



73 Bianco / Deflettore nero
White / Black baffle

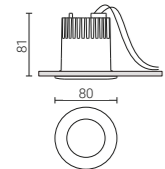

h 81 mm Ø 70 mm 0,4 Kg

Codice Code	LED Lumen	Product Lumen	Watt	mA	Colour T (K)	CRI	Fascio Beam
237-250BN	1250	1096	9	250	3000	80	26°
	1650	1447	12	350	3000	80	26°
237-250AN	1300	1140	9	250	4000	80	26°
	1700	1491	12	350	4000	80	26°

Driver da ordinare separatamente / Driver should be ordered separately

81-04009	Output 250mA
81-04042	Output 250mA Dimmerabile DALI / DALI dimmable
81-04010	Output 350mA Regolabile sul taglio di fase / Dimmable on the mains
81-04003	Output 350mA Dimmerabile DALI / DALI dimmable

CE ENEC IP65/20 IK08 UGR¹⁹

Accessori ottici intercambiabili / Replaceable optical accessories



28-3868-51
Optica professionale W
Professional optic device W
Fascio / Beam: 45°



28-3868-31
Optica professionale XW
Professional optic device XW
Fascio / Beam: 65°

RA 8 Q DIXIT LED



21 Bianco mat
Mat white

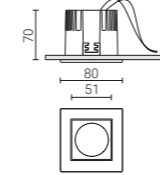

h 70 mm Ø 70 mm 0,4 Kg

Codice Code	LED Lumen	Product Lumen	Watt	mA	Colour T (K)	CRI	Fascio Beam
233-250BN	1250	1096	9	250	3000	80	26°
	1650	1447	12	350	3000	80	26°

Driver da ordinare separatamente / Driver should be ordered separately

81-04009	Output 250mA
81-04042	Output 250mA Dimmerabile DALI / DALI dimmable
81-04010	Output 350mA Regolabile sul taglio di fase / Dimmable on the mains
81-04003	Output 350mA Dimmerabile DALI / DALI dimmable

CE ENEC IP43 IK08 UGR¹⁹

Accessori ottici intercambiabili / Replaceable optical accessories



28-3903-51
Optica professionale W
Professional optic device W
Fascio / Beam: 45°



28-3903-31
Optica professionale XW
Professional optic device XW
Fascio / Beam: 65°

RA 8 L TL DIXIT LED



21 Bianco mat
Mat white

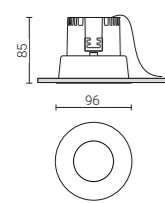

h 85 mm
Ø 92 mm
0,3 Kg

Codice Code	LED Lumen	Product Lumen	Watt	mA	Colour T (K)	CRI	Fascio Beam
234-239BN	550	501	5,5	350	3000	90	26°
	700	638	8,5	500	3000	90	26°

Driver da ordinare separatamente / Driver should be ordered separately

81-04007	Output 350mA Regolabile sul taglio di fase e 1-10V Dimmable on the mains and 1-10V
81-04003	Output 350mA Dimmerabile DALI / DALI dimmable
81-04008	Output 500mA Regolabile sul taglio di fase e 1-10V Dimmable on the mains and 1-10V
81-04002	Output 500mA Dimmerabile DALI / DALI dimmable

CE RoHS ENEC IP43 IK08 UGR-10

RA 8 SOFT DIXIT LED



21 Bianco mat
Mat white

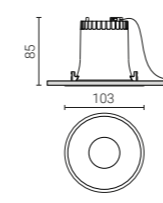

h 85 mm
Ø 96 mm
0,3 Kg

Codice Code	LED Lumen	Product Lumen	Watt	mA	Colour T (K)	CRI	Fascio Beam
238-039BN	1050	766	9	250	3000	90	26°
	1400	1022	12	350	3000	90	26°

Driver da ordinare separatamente / Driver should be ordered separately

81-04009	Output 250mA
81-04042	Output 250mA Dimmerabile DALI / DALI dimmable
81-04010	Output 350mA Regolabile sul taglio di fase / Dimmable on the mains
81-04003	Output 350mA Dimmerabile DALI / DALI dimmable

CE RoHS ENEC IP43 IK08 UGR-16

RA 8 TL DIXIT LED



21 Bianco mat
Mat white

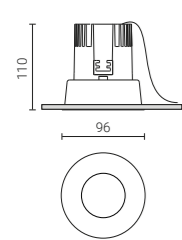

h 110 mm
Ø 92 mm
0,4 Kg

Codice Code	LED Lumen	Product Lumen	Watt	mA	Colour T (K)	CRI	Fascio Beam
234-259BN	1050	921	9	250	3000	90	26°
	1400	1228	12	350	3000	90	26°

Driver da ordinare separatamente / Driver should be ordered separately

81-04009	Output 250mA
81-04042	Output 250mA Dimmerabile DALI / DALI dimmable
81-04010	Output 350mA Regolabile sul taglio di fase / Dimmable on the mains
81-04003	Output 350mA Dimmerabile DALI / DALI dimmable

CE RoHS ENEC IP43 IK08 UGR-12

Accessori ottici intercambiabili / Replaceable optical accessories



28-3868-51
Optica professionale W
Professional optic device W
Fascio / Beam: 45°



28-3868-31
Optica professionale XW
Professional optic device XW
Fascio / Beam: 65°

RA 8 DIXIT LED

OSCILLANTE / TILTABLE



21 Bianco mat
Mat white

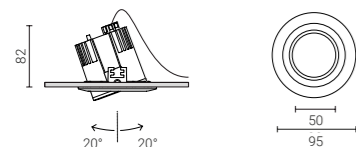

h 82 mm
Ø 50 mm
0,4 Kg

Codice Code	LED Lumen	Product Lumen	Watt	mA	Colour T (K)	CRI	Fascio Beam
239-250BN	1250	1096	9	250	3000	80	26°
	1650	1447	12	350	3000	80	26°
239-250AN	1300	1140	9	250	4000	80	26°
	1700	1491	12	350	4000	80	26°

Driver da ordinare separatamente / Driver should be ordered separately

81-04009 Output 250mA

81-04042 Output 250mA
Dimmerabile DALI / DALI dimmable

81-04010 Output 350mA
Regolabile sul taglio di fase / Dimmable on the mains

81-04003 Output 350mA
Dimmerabile DALI / DALI dimmable

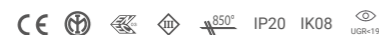

RA 8 DIXIT LED IP66

OSCILLANTE / TILTABLE



21 Bianco mat
Mat white

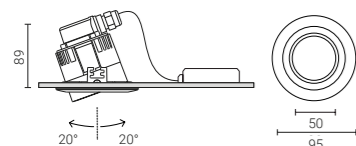

h 89 mm
Ø 50 mm
0,7 Kg

Codice Code	LED Lumen	Product Lumen	Watt	Colour T (K)	CRI	Fascio Beam
LED driver incluso / LED driver included						
235-250B	1650	1447	12	3000	80	26°

220/240V - 50/60Hz

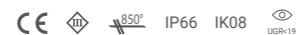

Accessori ottici intercambiabili / Replaceable optical accessories

28-3868-51
Ottica professionale W
Professional optic device W
Fascio / Beam: 45°

28-3868-31
Ottica professionale XW
Professional optic device XW
Fascio / Beam: 65°

RA 11 DIXIT LED



21 Bianco mat
Mat white

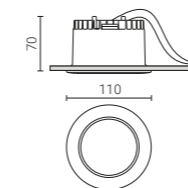

h 70 mm
Ø 110 mm
0,6 Kg

Codice Code	LED Lumen	Product Lumen	Watt	mA	Colour T (K)	CRI	Fascio Beam
255-200BN	1700	1513	12	350	3000	85	55°
	2350	2092	18	500	3000	85	55°
	3100	2759	26	700	3000	85	55°
255-200AN	1800	1602	12	350	4000	85	55°
	2450	2180	18	500	4000	85	55°
	3200	2848	26	700	4000	85	55°

Driver da ordinare separatamente / Driver should be ordered separately

81-04010 Output 350mA

Regolabile sul taglio di fase / Dimmable on the mains

81-04003 Output 350mA
Dimmerabile DALI / DALI dimmable

81-04011 Output 500mA

81-04002 Output 500mA
Dimmerabile DALI / DALI dimmable

81-04012 Output 700mA

81-04044 Output 700mA
Regolabile sul taglio di fase / Dimmable on the mains

81-02413 Output 700mA
Dimmerabile DALI / DALI dimmable

81-04066 Output 700mA
Regolabile 1-10V / Push
Dimmable 1-10V / Push



Accessori ottici intercambiabili / Replaceable optical accessories

28-3140-51
Ottica professionale S (diffusore incluso)
Professional optic device S (included diffuser)
Fascio / Beam: 18°

28-3142-51
Ottica professionale M
Professional optic device M
Fascio / Beam: 30°

28-3141-31
Ottica professionale XW
Professional optic device XW
Fascio / Beam: 70°

28-4019-30
Frangiluce alveolare
Honeycomb

RA 11 Q DIXIT LED



21 Bianco mat
Mat white

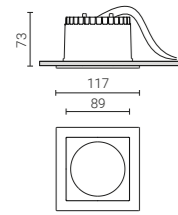

h 73 mm Ø 110 mm 0,7 Kg

Codice Code	LED Lumen	Product Lumen	Watt	mA	Colour T (K)	CRI	Fascio Beam
259-200BN	1700	1513	12	350	3000	85	55°
	2350	2092	18	500	3000	85	55°
	3100	2759	26	700	3000	85	55°

Driver da ordinare separatamente / Driver should be ordered separately

81-04010	Output 350mA Regolabile sul taglio di fase / Dimmable on the mains
81-04003	Output 350mA Dimmerabile DALI / DALI dimmable
81-04011	Output 500mA
81-04002	Output 500mA Dimmerabile DALI / DALI dimmable
81-04012	Output 700mA
81-04044	Output 700mA Regolabile sul taglio di fase / Dimmable on the mains
81-02413	Output 700mA Dimmerabile DALI / DALI dimmable
81-04066	Output 700mA Regolabile 1-10V / Push Dimmable 1-10V / Push

CE RoHS ENEC IP43 IK08 UGR-19

RA 11 TL DIXIT LED



21 Bianco mat
Mat white

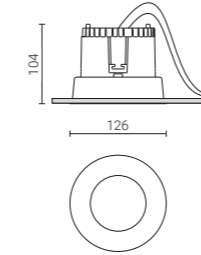

h 104 mm Ø 122 mm 0,6 Kg

Codice Code	LED Lumen	Product Lumen	Watt	mA	Colour T (K)	CRI	Fascio Beam
257-200BN	1700	1513	12	350	3000	85	55°
	2350	2092	18	500	3000	85	55°
	3100	2759	26	700	3000	85	55°

Driver da ordinare separatamente / Driver should be ordered separately

81-04010	Output 350mA Regolabile sul taglio di fase / Dimmable on the mains
81-04003	Output 350mA Dimmerabile DALI / DALI dimmable
81-04011	Output 500mA
81-04002	Output 500mA Dimmerabile DALI / DALI dimmable
81-04012	Output 700mA
81-04044	Output 700mA Regolabile sul taglio di fase / Dimmable on the mains
81-02413	Output 700mA Dimmerabile DALI / DALI dimmable
81-04066	Output 700mA Regolabile 1-10V / Push Dimmable 1-10V / Push

CE RoHS ENEC IP43 IK08 UGR-19

Accessori ottici intercambiabili / Replaceable optical accessories



28-3140-51
Ottica professionale S (diffusore incluso)
Professional optic device S (included diffuser)
Fascio / Beam: 18°



28-3142-51
Ottica professionale M
Professional optic device M
Fascio / Beam: 30°



28-3141-31
Ottica professionale XW
Professional optic device XW
Fascio / Beam: 70°



28-4019-30
Frangiluce alveolare
Honeycomb

Accessori ottici intercambiabili / Replaceable optical accessories



28-3140-51
Ottica professionale S (diffusore incluso)
Professional optic device S (included diffuser)
Fascio / Beam: 18°



28-3142-51
Ottica professionale M
Professional optic device M
Fascio / Beam: 30°



28-3141-31
Ottica professionale XW
Professional optic device XW
Fascio / Beam: 70°



28-4019-30
Frangiluce alveolare
Honeycomb

RA 11 SOFT DIXIT LED



21 Bianco mat
Mat white

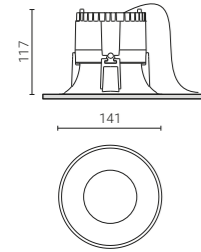

h 117 mm Ø 134 mm 0,7 Kg

Codice Code	LED Lumen	Product Lumen	Watt	mA	Colour T (K)	CRI	Fascio Beam
258-200BN	1700	1513	12	350	3000	85	55°
	2350	2092	18	500	3000	85	55°
	3100	2759	26	700	3000	85	55°

Driver da ordinare separatamente / Driver should be ordered separately

81-04010	Output 350mA Regolabile sul taglio di fase / Dimmable on the mains
81-04003	Output 350mA Dimmerabile DALI / DALI dimmable
81-04011	Output 500mA
81-04002	Output 500mA Dimmerabile DALI / DALI dimmable
81-04012	Output 700mA
81-04044	Output 700mA Regolabile sul taglio di fase / Dimmable on the mains
81-02413	Output 700mA Dimmerabile DALI / DALI dimmable
81-04066	Output 700mA Regolabile 1-10V / Push Dimmable 1-10V / Push



RA 11 DIXIT LED OSCILLANTE / TILTABLE



21 Bianco mat
Mat white

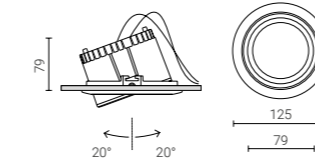

h 79 mm Ø 116 mm 0,7 Kg

Codice Code	LED Lumen	Product Lumen	Watt	mA	Colour T (K)	CRI	Fascio Beam
256-200BN	1700	1513	12	350	3000	85	55°
	2350	2092	18	500	3000	85	55°
	3100	2759	26	700	3000	85	55°
256-200AN	1800	1602	12	350	4000	85	55°
	2450	2180	18	500	4000	85	55°
	3200	2848	26	700	4000	85	55°

Driver da ordinare separatamente / Driver should be ordered separately

81-04010	Output 350mA Regolabile sul taglio di fase / Dimmable on the mains
81-04003	Output 350mA Dimmerabile DALI / DALI dimmable
81-04011	Output 500mA
81-04002	Output 500mA Dimmerabile DALI / DALI dimmable
81-04012	Output 700mA
81-04044	Output 700mA Regolabile sul taglio di fase / Dimmable on the mains
81-02413	Output 700mA Dimmerabile DALI / DALI dimmable
81-04066	Output 700mA Regolabile 1-10V / Push Dimmable 1-10V / Push



Accessori ottici intercambiabili / Replaceable optical accessories



28-3140-51
Ottica professionale S (diffusore incluso)
Professional optic device S (included diffuser)
Fascio / Beam: 18°



28-3142-51
Ottica professionale M
Professional optic device M
Fascio / Beam: 30°



28-3141-31
Ottica professionale XW
Professional optic device XW
Fascio / Beam: 70°



28-4019-30
Frangiluce alveolare
Honeycomb



28-3140-51
Ottica professionale S (diffusore incluso)
Professional optic device S (included diffuser)
Fascio / Beam: 18°



28-3142-51
Ottica professionale M
Professional optic device M
Fascio / Beam: 30°



28-3141-31
Ottica professionale XW
Professional optic device XW
Fascio / Beam: 70°



28-4019-30
Frangiluce alveolare
Honeycomb



RA 8 Q Dixit LED

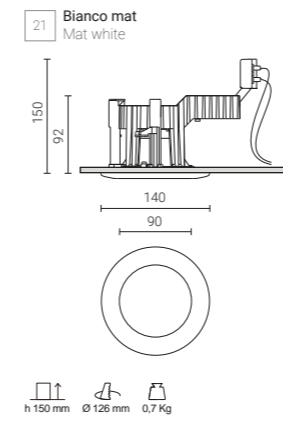

Codice Code	LED Lumen	Product Lumen	Watt	mA	Colour T (K)	CRI	Fascio Beam
Schermo di chiusura in vetro temprato (4 mm) Tempered safety glass (4 mm)							
243-250BN	3400	2924	26	700	3000	85	60°
	4250	3655	33	900	3000	85	60°
	4900	4214	38	1050	3000	85	60°
243-250AN	3500	3010	26	700	4000	85	60°
	4400	3784	33	900	4000	85	60°
	5000	4300	38	1050	4000	85	60°

Driver da ordinare separatamente / Driver should be ordered separately

- 81-04012** Output 700mA
- 81-04044** Output 700mA
Regolabile sul taglio di fase / Dimmable on the mains
- 81-02413** Output 700mA
Dimmerabile DALI / DALI dimmable
- 81-04066** Output 700mA
Regolabile 1-10V / Push
Dimmable 1-10V / Push
- 81-04015** Output 900mA
- 81-04013** Output 1050mA
- 81-04014** Output 1050mA
Dimmerabile DALI / DALI dimmable

CE IP43 IK08

Accessori ottici intercambiabili / Replaceable optical accessories

98-13380-61
Vetro sabbato
Frosted glass

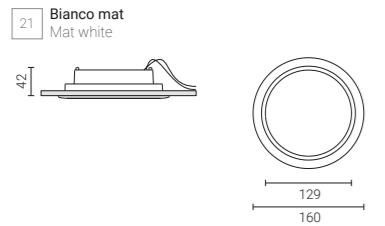

h 42 mm Ø 155 mm 0,7 Kg

Codice Code	LED Lumen	Product Lumen	Watt	mA	Colour T (K)	CRI	Fascio Beam
Schermo di chiusura in policarbonato opale Closing screen in opal polycarbonate							
250-220BN	2400	1728	18	500	3000	85	110°
250-220AN	2450	1764	18	500	4000	85	110°
250-230BN	3100	2232	26	700	3000	85	110°
Driver da ordinare separatamente / Driver should be ordered separately							
81-04011	Output 500mA						
81-04002	Output 500mA Dimmerabile DALI / DALI dimmable						
81-04012	Output 700mA						
81-04044	Output 700mA Regolabile sul taglio di fase / Dimmable on the mains						
81-02413	Output 700mA Dimmerabile DALI / DALI dimmable						
81-04066	Output 700mA Regolabile 1-10V / Push Dimmable 1-10V / Push						

CE IP43 IK07

RA 17 DIXIT LED
OSCILLANTE / TILTABLE

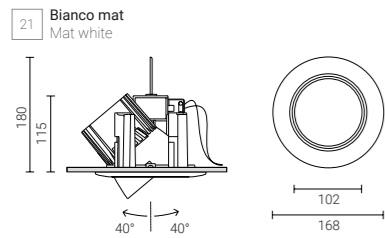

h 180 mm Ø 155 mm 2,0 Kg

Codice Code	LED Lumen	Product Lumen	Watt	mA	Colour T (K)	CRI	Fascio Beam
Schermo di chiusura in policarbonato trasparente Closing screen in clear polycarbonate							
248-230BN	4250	3770	33	900	3000	85	30°
Driver da ordinare separatamente / Driver should be ordered separately							
81-04015	Output 900mA						

CE IP20 IK07

Accessori ottici intercambiabili solo per RA 17 Dixit LED
Replaceable optical accessories only for RA 17 Dixit LED

28-3140-51
Ottica professionale S (diffusore incluso)
Professional optic device S (included diffuser)
Fascio / Beam: 17°

28-3138-51
Ottica professionale W
Professional optic device W
Fascio / Beam: 55°

28-3141-31
Ottica professionale XW
Professional optic device XW
Fascio / Beam: 70°

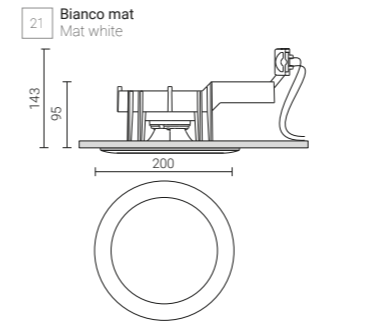

h 143 mm Ø 185 mm 1,8 Kg

Codice Code	LED Lumen	Product Lumen	Watt	mA	Colour T (K)	CRI	Fascio Beam
Schermo di chiusura in vetro temprato (4 mm) Tempered safety glass (4 mm)							
244-242BN	6400	5485	51	1400	3000	85	100°
244-242AN	6600	5656	51	1400	4000	85	100°
Driver da ordinare separatamente / Driver should be ordered separately							
81-04004	Output 1400mA (max 60W)						
81-04016	Output 1400mA (max 60W) Dimmerabile DALI / DALI dimmable						

CE IP43 IK07

RA 23 SP DIXIT LED

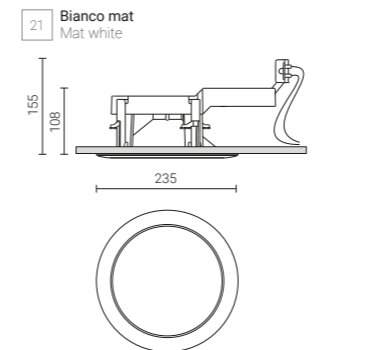

h 155 mm Ø 220 mm 3,6 Kg

Codice Code	LED Lumen	Product Lumen	Watt	mA	Colour T (K)	CRI	Fascio Beam
Schermo di chiusura in vetro temprato (4 mm) Tempered safety glass (4 mm)							
249-240BN	6800	5827	51	1400	3000	85	100°
249-240AN	7000	5998	51	1400	4000	85	100°
249-250BN	9900	9549	75	1400	3000	85	100°
Driver da ordinare separatamente / Driver should be ordered separately							
81-04004	Output 1400mA (max 60W)						
81-04016	Output 1400mA (max 60W) Dimmerabile DALI / DALI dimmable						
81-04018	Output 1400mA (max 100W)						

CE IP43 IK07

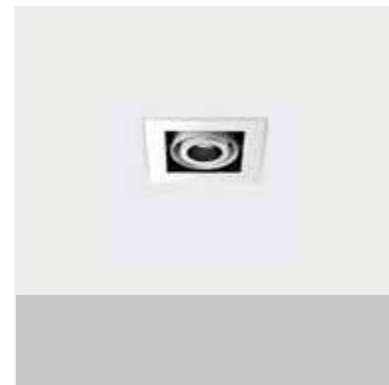

21 Bianco mat / Mat white
16 Nero / Black

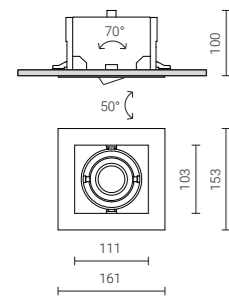

h 105 mm
135x130 mm
1.0 Kg

Codice Code	LED Lumen	Product Lumen	Watt	mA	Colour T (K)	CRI	Fascio Beam
Con cornice, per applicazione a incasso With frame, for recessed application							
508-211BN	1x1700	1x1241	1x12	350	3000	85	30°
	1x2400	1x1752	1x18	500	3000	85	30°
508-211AN	1x1800	1x1314	1x12	350	4000	85	30°
	1x2500	1x1825	1x18	500	4000	85	30°

Driver da ordinare separatamente / Driver should be ordered separately

- 81-04010** Output 350mA
Regolabile sul taglio di fase / Dimmable on the mains
- 81-04003** Output 350mA
Dimmerabile DALI / DALI dimmable
- 81-04011** Output 500mA
- 81-04002** Output 500mA
Dimmerabile DALI / DALI dimmable

CE, RoHS, Energy Star, DALI, IP20



21 Bianco mat / Mat white
16 Nero / Black

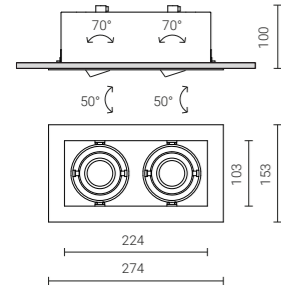

h 105 mm
135x245 mm
2.0 Kg

Codice Code	LED Lumen	Product Lumen	Watt	mA	Colour T (K)	CRI	Fascio Beam
Con cornice, per applicazione a incasso With frame, for recessed application							
508-221BN	2x1700	2x1241	2x12	2x350	3000	85	30°
	2x2400	2x1752	2x18	2x500	3000	85	30°
508-221AN	2x1800	2x1314	2x12	2x350	4000	85	30°
	2x2500	2x1825	2x18	2x500	4000	85	30°

Driver da ordinare separatamente / Driver should be ordered separately

- 81-04012** Output 700mA (2x350mA)
- 81-04066** Output 700mA (2x350mA)
Regolabile 1-10V / Push
Dimmable 1-10V / Push
- 81-04021** Output 1000mA (2x500mA)

CE, RoHS, Energy Star, DALI, IP20

Accessori ottici intercambiabili / Replaceable optical accessories

28-3901-51
Ottica professionale S
Professional optic device S
Fascio / Beam: 24°

28-3903-51
Ottica professionale W
Professional optic device W
Fascio / Beam: 45°

28-3903-31
Ottica professionale XW
Professional optic device XW
Fascio / Beam: 55°

28-3905-47
Schermo di chiusura in termoplastico trasparente
Closing screen in clear thermoplastic material

28-4536-30
Frangiluce alveolare
Honeycomb

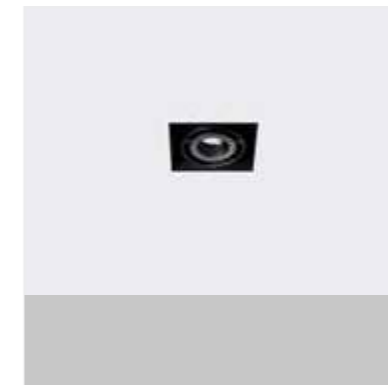

16 Nero / Black

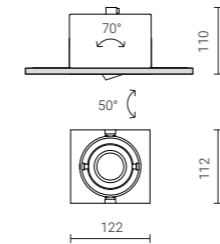

h 170 mm
115x124 mm
1.0 Kg

Codice Code	LED Lumen	Product Lumen	Watt	mA	Colour T (K)	CRI	Fascio Beam
Senza cornice, per applicazione a incasso Trimless, for recessed application							
509-211BN	1x1700	1x1241	1x12	350	3000	85	30°
	1x2400	1x1752	1x18	500	3000	85	30°
509-211AN	1x1800	1x1314	1x12	350	4000	85	30°
	1x2500	1x1825	1x18	500	4000	85	30°

Driver da ordinare separatamente / Driver should be ordered separately

- 81-04010** Output 350mA
Regolabile sul taglio di fase / Dimmable on the mains
- 81-04003** Output 350mA
Dimmerabile DALI / DALI dimmable
- 81-04011** Output 500mA
- 81-04002** Output 500mA
Dimmerabile DALI / DALI dimmable

CE, RoHS, Energy Star, DALI, IP20

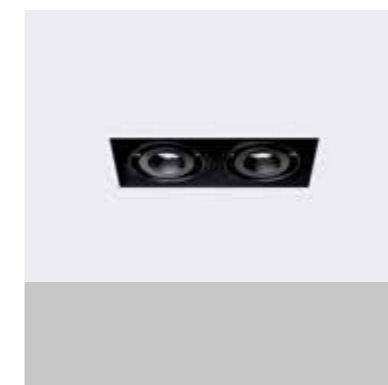

16 Nero / Black

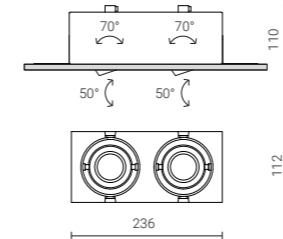

h 170 mm
115x238 mm
2.0 Kg

Codice Code	LED Lumen	Product Lumen	Watt	mA	Colour T (K)	CRI	Fascio Beam
Senza cornice, per applicazione a incasso Trimless, for recessed application							
509-221BN	2x1700	2x1241	2x12	2x350	3000	85	30°
	2x2400	2x1752	2x18	2x500	3000	85	30°
509-221AN	2x1800	2x1314	2x12	2x350	4000	85	30°
	2x2500	2x1825	2x18	2x500	4000	85	30°

Driver da ordinare separatamente / Driver should be ordered separately

- 81-04012** Output 700mA (2x350mA)
- 81-04066** Output 700mA (2x350mA)
Regolabile 1-10V / Push
Dimmable 1-10V / Push
- 81-04021** Output 1000mA (2x500mA)

CE, RoHS, Energy Star, DALI, IP20

Accessori ottici intercambiabili / Replaceable optical accessories

28-3901-51
Ottica professionale S
Professional optic device S
Fascio / Beam: 24°

28-3903-51
Ottica professionale W
Professional optic device W
Fascio / Beam: 45°

28-3903-31
Ottica professionale XW
Professional optic device XW
Fascio / Beam: 55°

28-3905-47
Schermo di chiusura in termoplastico trasparente
Closing screen in clear thermoplastic material

28-4536-30
Frangiluce alveolare
Honeycomb

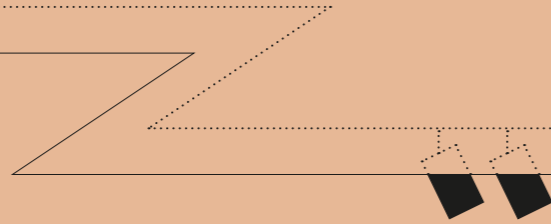
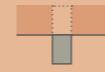

Lo sguardo segue percorsi di luce

The eye follows paths of light

^{ITA} I sistemi da incasso sono gli autori di coreografie sempre nuove, perché l'effetto di continuità luminosa sui soffitti è personalizzabile per creare combinazioni ogni volta inedite. Le necessità architettoniche sono ampiamente corrisposte dal design del prodotto.

^{EN} Recessed systems are the authors of ever-new choreographies, because the effect of luminous continuity on the ceilings can be customized to create combinations that are new every time. The architectural needs are certainly matched by the product design.





Broadway

^{ITA} Applicato in controsoffitti di cartongesso, consente l'installazione di apparecchi a scomparsa. È costituito da due misure di profili in alluminio estruso in finitura nera, con o senza binario elettrificato trifase oppure monofase dimmerabile DALI.

Tramite un innovativo sistema di ancoraggio a slitta, sul binario si posizionano proiettori cilindrici, con sorgenti luminose LED COB e lenti siliciche.

^{EN} Installed in plasterboard false ceilings, Broadway allows the installation of retractable light fittings. It consists of two extruded aluminium profiles in black finish, with a three-phase or DALI dimmable single-phase electrified track as an option.

The cylindrical spotlights are equipped with the last generation of LEDs and silicone lenses. They can be anchored to the track through an innovative slide fixing system.

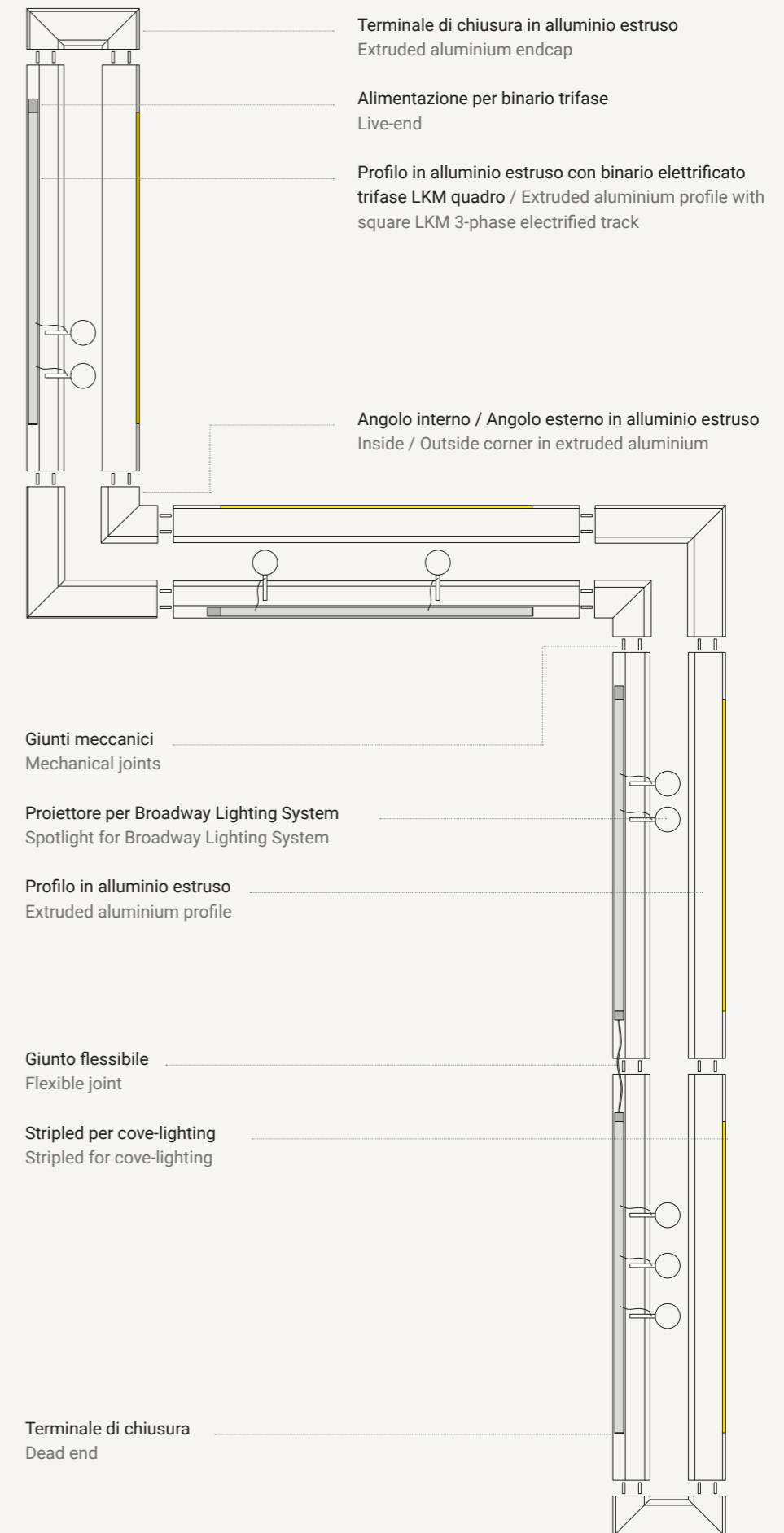



ITA La luce all'interno dei profili genera composizioni flessibili e dinamiche.

EN The light inside the profiles generates flexible and dynamic compositions.

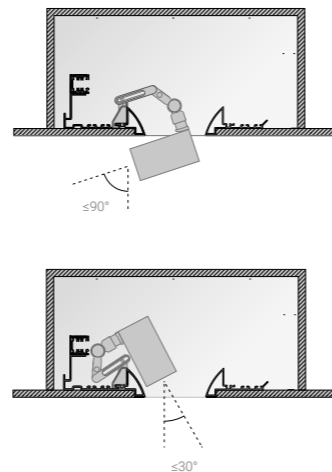

ITA Il sistema Broadway è innovativo e coerente. Inserito in un ambiente sobrio, ma elegante e ricercato, è in grado di trasformarsi da punto luce a vero e proprio complemento d'arredo.

EN The Broadway recessed system is innovative and consistent. Integrated into a sober but elegant and refined environment, it can transform itself from a light point into a real piece of furniture.



Broadway con proiettore custom per progetto residenziale
Broadway with custom spotlight for a residential project



Villa Mirella - Ruta di Camogli (Interior & Lighting Design: SLAM Architects)

Sistemi da incasso

Recessed systems



INDEX

Products

Pages



Broadway

94



Microperfetto Large Broadway with lens

96



Microperfetto Large Broadway zoom

97

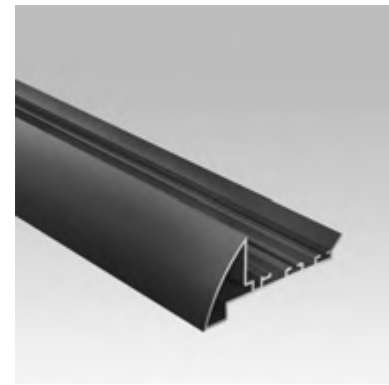

Codice Code	Lunghezza Length (mm)	Kg
Profilo in alluminio estruso Extruded aluminium profile		
7842-13	1300	3,5
7842-23	2300	6,1

16 Nero Black

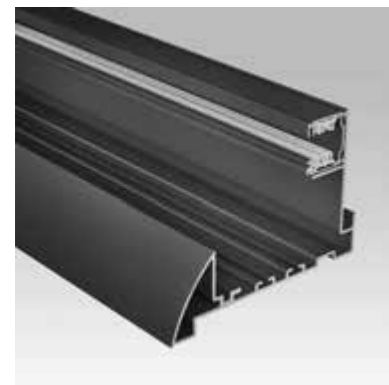
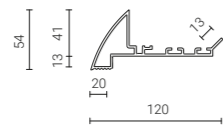
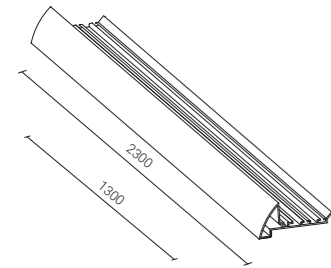

Profilo in alluminio estruso con binario elettrificato trifase LKM quadro Extruded aluminium profile with square LKM three-phase electrified track			
7841-13	1300	Binario / Track 1000mm	4,4
7841-23	2300	Binario / Track 2000mm	7,9

Profilo in alluminio estruso con binario elettrificato monofase DKM dimmerabile DALI Extruded aluminium profile with DALI dimmable DKM single-phase electrified track			
7841-13D	1300	Binario / Track 1000mm	4,4
7841-23D	2300	Binario / Track 2000mm	7,9

16 Nero Black

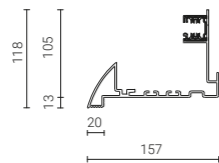
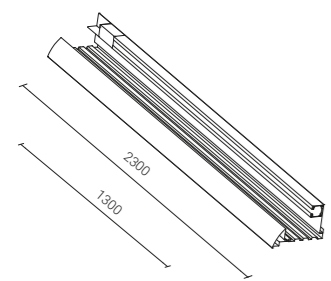

Accessori per binario trifase LKM quadro / monofase DKM dimmerabile DALI
Accessories for LKM three-phase / DALI dimmable DKM single-phase square track

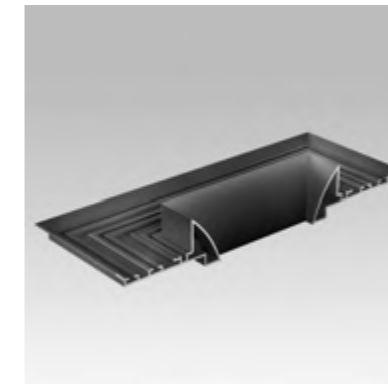
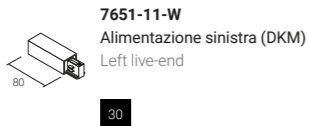
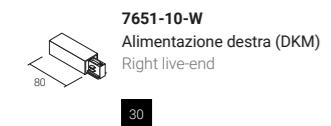
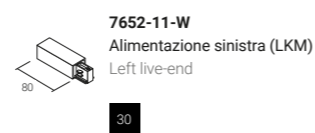
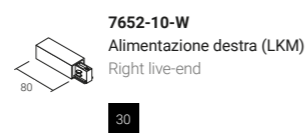

Codice Code	Kg
Terminale di chiusura in alluminio estruso Extruded aluminium endcap	
7850-00	0,7

16 Nero Black

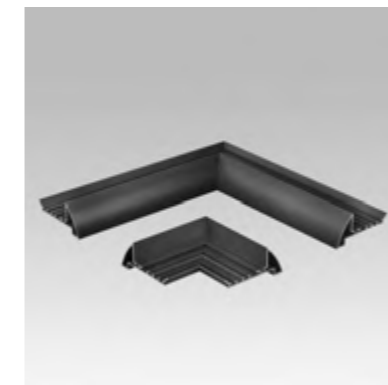
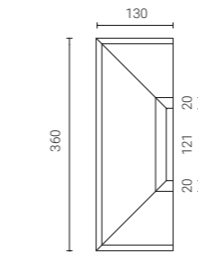

Angolo interno / esterno in alluminio estruso Inside / outside corner in extruded aluminium		
7850I-00	Interno / Inside	0,4
7850E-00	Esterno / Outside	2,1

7851-00-00	Giunto meccanico (kit da 4 pezzi) Mechanical joint (4 pieces kit)	12
-------------------	--	----

16 Nero Black

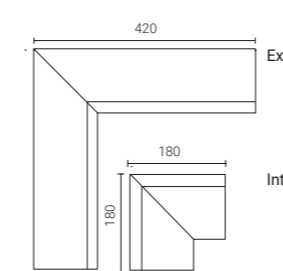

MICROPERFETTO LARGE BROADWAY
CON LENTE / WITH LENS



Codice Code	LED Lumen	Product Lumen	Watt	Colour T (K)	CRI	Fascio Beam
Max 4 apparecchi per ogni profilo da 1300 mm. Max 8 apparecchi per ogni profilo da 2300 mm / Max 4 fittings for each 1300 mm profile. Max 8 fittings for each 2300 mm profile						
788-369B	2760	2346	25	3000	90	24°
788-369C	2650	2253	25	2700	90	24°
Per profilo Broadway con binario elettrificato monofase DKM dimmerabile DALI For Broadway profile with DALI dimmable DKM single-phase electrified track						
788-369BDD	2760	2346	25	3000	90	24°
788-369CDD	2650	2253	25	2700	90	24°

16 Nero
Black

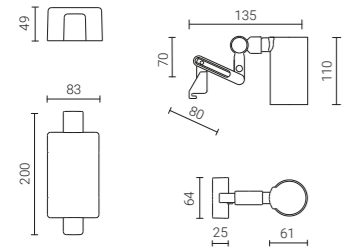

220/240V - 50/60Hz



MICROPERFETTO LARGE BROADWAY
ZOOM

Sistemi da incasso Recessed systems



Codice Code	LED Lumen	Product Lumen	Watt	Colour T (K)	CRI	Fascio Beam
Max 5 apparecchi per ogni profilo da 1300 mm. Max 10 apparecchi per ogni profilo da 2300 mm / Max 5 fittings for each 1300 mm profile. Max 10 fittings for each 2300 mm profile						
787-069B	1310	1114	12,4	3000	90	13° to 47°
787-069C	1216	1034	12,4	2700	90	13° to 47°
Per profilo Broadway con binario elettrificato monofase DKM dimmerabile DALI For Broadway profile with DALI dimmable DKM single-phase electrified track						
787-369BDD	1310	1114	12,4	3000	90	13° to 47°
787-369CDD	1216	1034	12,4	2700	90	13° to 47°

16 Nero
Black

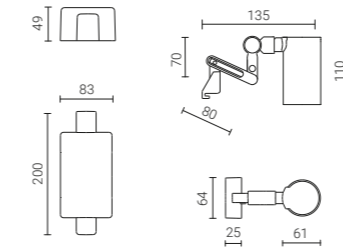

220/240V - 50/60Hz



Zoom technology

La rotazione del cilindro interno permette di modificare l'angolo del fascio da 13° a 47°.

The rotation of the internal snoot modifies the beam angle from 13° to 47°.

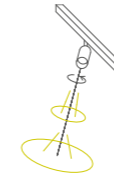

**Proiettori
da semi-incasso
e superficie**

**Semi-recessed/
surface spotlights**

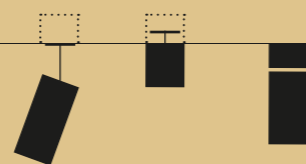
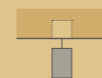

Eleganti combinazioni di atmosfere

Elegant combinations of atmospheres

^{ITA} Apparecchi versatili per applicazioni che danno vita a geometrie di luce e volumi nello spazio. Grazie ad accessori ottici intercambiabili, sono in grado di generare luce d'ambiente o d'accento illuminando gli ambienti interni con stile ed eleganza. Il design rigoroso consente applicazioni in qualsiasi tipologia di contesto indoor, armonizzando stile e funzionalità. Alcuni proiettori possono essere installati direttamente su soffitto o parete, altri invece prevedono un'installazione recessata.

^{EN} Versatile light fittings for surface mounted applications, that generate luminous geometries and volumes in the space. Using replaceable optical accessories, these fittings can both be used for general or accent lighting in any interior context combining functionality and elegant design. The rigorous design allows applications in any interior applications, harmonising style and functionality. Some spotlights can be mounted directly on the ceiling or on the wall, others should be installed as recessed fittings.



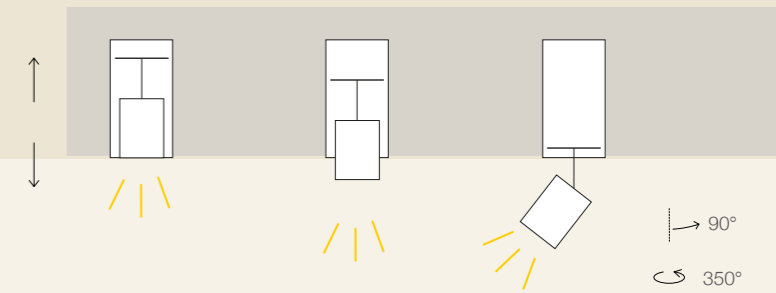

La luce è in movimento

Light is moving

^{ITA} Piccolo proiettore da incasso caratterizzato da una massima flessibilità di utilizzo. Il corpo illuminante può essere estratto dalla cornice in diverse posizioni. Nanoperfetto UP è altamente flessibile grazie alla sua rotazione e inclinazione. Ideale per l'illuminazione d'accento di negozi, showroom e spazi espositivi, diventa lo strumento perfetto per i lighting designer più esigenti, grazie alle infinite possibilità di installazione e alle combinazioni di accessori ottici.

^{EN} Small, recessed spotlight featuring a maximum flexibility in use. Lighting body can be pulled out from the bezel in different positions. Nanoperfetto UP is highly flexible thanks to its rotation and inclination. Ideal for accent lighting in retail, showrooms, and exhibition spaces. It becomes the perfect tool for lighting designers, thanks to the almost infinite possibilities of installation and to the different combinations of optical accessories.

**Proiettori
da semi-incasso
e superficie**

**Semi-recessed/
surface spotlights**



Private residence Neuilly-sur-Seine (Interior & Lighting design: SLAM Architects)



**Express your
personality**

^{ITA} Miniperfetto Base è sinonimo di versatilità: un design, molteplici applicazioni, per offrire soluzioni illuminotecniche personalizzate e flessibili, ideali per ogni esigenza progettuale.

^{EN} Miniperfetto Base is synonymous with versatility: one design, multiple applications, for customized and flexible lighting solutions, ideal for every design requirement.





^{ITA} Microperfetto-R e Microperfetto Cupcake grazie alla forma cilindrica che li accomuna sono perfettamente integrabili in ogni ambiente e contesto. La finitura custom dona ai prodotti maggior carattere e originalità.

^{EN} Microperfetto-R and Microperfetto Cupcake, thanks to the cylindrical shape they have in common, can be perfectly integrated into any environment and context. The custom finish gives the products a modern character and originality.

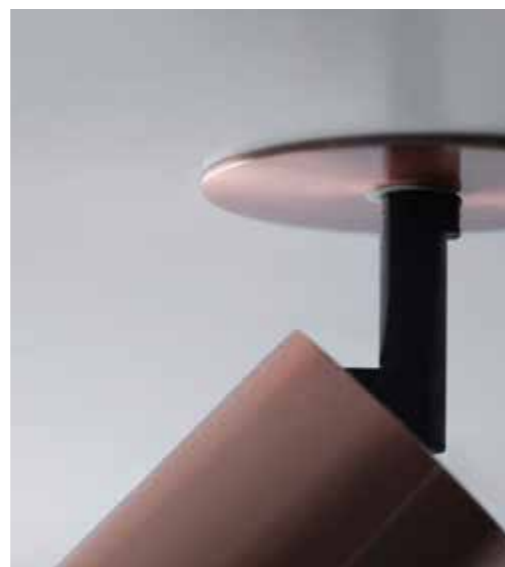

Dettaglio di snodo e rosone del Nanoperfetto-R, in finitura custom.

Detail of joint and canopy of Nanoperfetto-R, with a custom finish.

**Proiettori
da semi-incasso
e superficie**

**Semi-recessed/
surface spotlights**



INDEX

Products

Pages



Nanoperfetto UP

106



Nanoperfetto-R

108



Nanoperfetto Base

109



Microperfetto Low-R

110



Microperfetto Cupcake

111



Microperfetto Large-R / Microperfetto Large-R Zoom

112



Microperfetto Large Base Zoom

113



Miniperfetto Base

114

NANOPERFETTO UP

Proiettori da semi-incasso e superficie Semi-recessed/surface spotlights

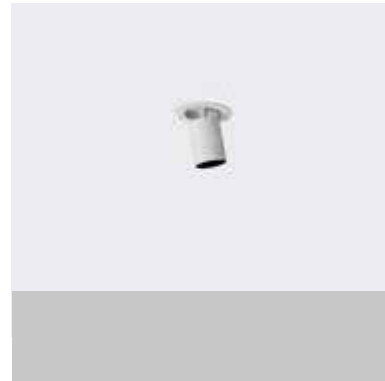

Codice Code	LED Lumen	Product Lumen	Watt	mA	Colour T (K)	CRI	Fascio Beam
-------------	-----------	---------------	------	----	--------------	-----	-------------

Proiettore estraibile per applicazione a incasso, con lente PMMA
Pull-down spotlight for recessed application, with PMMA lens

269-039BN	441	379	4	350	3000	90	21°
269-039BWN	441	379	4	350	3000	90	38°
269-039CN	417	359	4	350	2700	90	21°
269-039CWN	417	359	4	350	2700	90	38°

Driver da ordinare separatamente / Driver should be ordered separately

81-02408 Output 350mA

21 Bianco mat
Mat white

16 Nero
Black

CE IP20

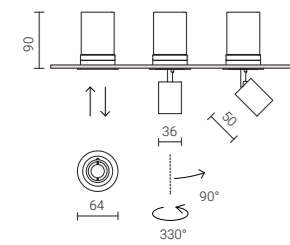

h 90 mm
 Ø 58 mm
 0,3 Kg



Nanoperfetto UP

Accessori ottici intercambiabili / Replaceable optical accessories



28-4499-30
Frangiluce alveolare
Honeycomb

NANOPERFETTO - R

CON LENTE / WITH LENS



21 Bianco mat
Mat white

16 Nero
Black

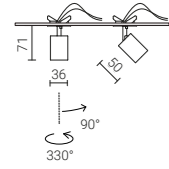

h 50 mm
Ø 42 mm
0,1 Kg

Codice Code	LED Lumen	Product Lumen	Watt	mA	Colour T (K)	CRI	Fascio Beam
Con lente in PMMA e rosone per applicazione a incasso With PMMA lens and canopy for recessed application							
755-779BN	611	525	6	500	3000	90	21°
	713	613	7,3	600	3000	90	21°
755-779BWN	611	525	6	500	3000	90	38°
	713	613	7,3	600	3000	90	38°
755-779BRN	611	525	6	500	3000	90	15°+41°
	713	613	7,3	600	3000	90	15°+41°
755-779CN	579	498	6	500	2700	90	21°
	675	581	7,3	600	2700	90	21°
755-779CWN	579	498	6	500	2700	90	38°
	675	581	7,3	600	2700	90	38°
755-779CRN	579	498	6	500	2700	90	15°+41°
	675	581	7,3	600	2700	90	15°+41°
⚡ 755-679MN	494*	420	5	300	1800-2700 Dim to Warm	90	21°
⚡ 755-679MWN	494*	420	5	300	1800-2700 Dim to Warm	90	38°
⚡ 755-679MRN	494*	420	5	300	1800-2700 Dim to Warm	90	15°+41°

*Valore riferito alla massima dimmerazione / Value referring to max dimming

Driver da ordinare separatamente, per installazione attraverso il foro d'incasso
Driver should be ordered separately, for installation through the recessed hole

81-04029	Output 500mA Regolabile sul taglio di fase / Dimmable on the mains
81-04026	Output 500mA* Dimmerabile DALI / DALI dimmable

* Per una corretta installazione, considerare una profondità di incasso a soffitto di 200 mm
For a correct installation, please consider a ceiling recessed depth of 200 mm

Driver da ordinare separatamente, per installazione in posizione remota
Driver should be ordered separately, for remote installation

⚡ 81-04075	Output 300mA Regolabile sul taglio di fase / Dimmable on the mains
⚡ 81-04072	Output 300mA Dimmerabile 1-10V / 1-10V dimmable
⚡ 81-04074	Output 300mA Dimmerabile DALI / DALI dimmable
81-04063	Output 600mA
81-04062	Output 600mA Dimmerabile DALI / DALI dimmable

CE RoHS ENEC IP20

Accessori ottici intercambiabili / Replaceable optical accessories

28-4499-30
Frangiluce alveolare (solo per 5W e 6W)
Honeycomb (only for 5W and 6W)

NANOPERFETTO BASE

Proiettori da semi-incasso e superficie Semi-recessed/surface spotlights

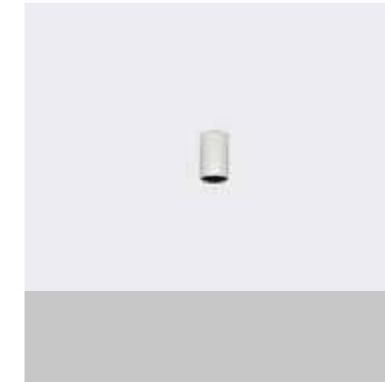

21 Bianco mat
Mat white

16 Nero
Black

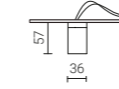

0,1 Kg

Codice Code	LED Lumen	Product Lumen	Watt	mA	Colour T (K)	CRI	Fascio Beam
Fisso con lente in PMMA e base per applicazione a superficie Fixed with PMMA lens and base for surface application							
752-729BYN0	611	525	6	500	3000	90	21°
752-729BWN0	611	525	6	500	3000	90	38°
752-729CYN0	579	498	6	500	2700	90	21°
752-729CWN0	579	498	6	500	2700	90	38°
⚡ 752-729MYN0	494*	420	5	300	1800-2700 Dim to Warm	90	21°
⚡ 752-729MWN0	494*	420	5	300	1800-2700 Dim to Warm	90	38°

*Valore riferito alla massima dimmerazione / Value referring to max dimming

Driver da ordinare separatamente / Driver should be ordered separately

81-04029	Output 500mA Regolabile sul taglio di fase / Dimmable on the mains
81-04026	Output 500mA Dimmerabile DALI / DALI dimmable
⚡ 81-04075	Output 300mA Dimmerabile sulla fase / Dimmable on the mains
⚡ 81-04074	Output 300mA Dimmerabile DALI / DALI dimmable
⚡ 81-04072	Output 300mA Dimmerabile 1-10V / 1-10V dimmable

CE RoHS ENEC IP40

Accessori ottici intercambiabili / Replaceable optical accessories

28-4499-30
Frangiluce alveolare
Honeycomb

MICROPERFETTO LOW-R



21 Bianco mat
Mat white

16 Nero
Black

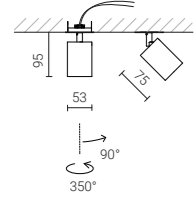

h 50 mm
Ø 55 mm
0,4 Kg

Codice Code	LED Lumen	Product Lumen	Watt	mA	Colour T (K)	CRI	Fascio Beam
Con vetro zigrinato e rosone per applicazione a incasso With prismatic spread lens and canopy for recessed application							
756-679BZN	1080	756	9	250	3000	90	16°
	1500	1050	12	350	3000	90	16°
	2051	1436	18	500	3000	90	16°
756-679BN	1080	756	9	250	3000	90	30°
	1500	1050	12	350	3000	90	30°
	2051	1436	18	500	3000	90	30°

756-679CZN	1050	735	9	250	2700	90	16°
	1390	973	12	350	2700	90	16°
	1946	1362	18	500	2700	90	16°
756-679CN	1050	735	9	250	2700	90	30°
	1390	973	12	350	2700	90	30°
	1946	1362	18	500	2700	90	30°

756-049MN	1130*	633	12	350	1800-2700 Dim to Warm	90	30°
------------------	-------	-----	----	-----	--------------------------	----	-----

*Valore riferito alla massima dimmerazione / Value referring to max dimming

Driver da ordinare separatamente / Driver should be ordered separately

81-04009	Output 250mA
81-04010	Output 350mA Regolabile sul taglio di fase (anche per Dim to Warm) Dimmable on the mains (also for Dim to Warm)
81-04003	Output 350mA Dimmerabile DALI (anche per Dim to Warm) DALI dimmable (also for Dim to Warm)
81-04011	Output 500mA
81-04002	Output 500mA Dimmerabile DALI / DALI dimmable

CE 850° IP20

MICROPERFETTO CUPCAKE

Proiettori da semi-incasso e superficie Semi-recessed/surface spotlights



21 Bianco mat
Mat white

16 Nero
Black

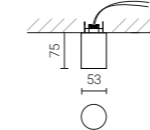

h 50 mm
Ø 42 mm
0,2 Kg

Codice Code	LED Lumen	Product Lumen	Watt	mA	Colour T (K)	CRI	Fascio Beam
Fisso con vetro zigrinato per applicazione ad incasso Fixed with prismatic spread lens for recessed application							
758-679BVN	1080	756	9	270	3000	90	45°
	1500	1050	12	350	3000	90	45°
	2051	1436	18	500	3000	90	45°
758-679CVN	1050	735	9	270	2700	90	45°
	1390	973	12	350	2700	90	45°
	1946	1362	18	500	2700	90	45°

762-049MVN	1130*	791	12	350	1800-2700 Dim to Warm	90	45°
-------------------	-------	-----	----	-----	--------------------------	----	-----

*Valore riferito alla massima dimmerazione / Value referring to max dimming

Driver da ordinare separatamente / Drivers should be ordered separately

81-04049	Output 270mA Regolabile sul taglio di fase / Dimmable on the mains
81-04020	Output 350mA
81-04010	Output 350mA Regolabile sul taglio di fase (anche per Dim to Warm) Dimmable on the mains (also for Dim to Warm)
81-04003	Output 350mA Dimmerabile DALI (per Dim to Warm) DALI dimmable (for Dim to Warm)
81-04046	Output 500mA*

* Per una corretta installazione, considerare una profondità di incasso a soffitto di 180 mm
For a correct installation, please consider a ceiling recessed depth of 180 mm

81-04026 Output 500mA*
Dimmerabile DALI / DALI dimmable

* Per una corretta installazione, considerare una profondità di incasso a soffitto di 200 mm
For a correct installation, please consider a ceiling recessed depth of 200 mm

CE 850° IP20

Accessori ottici intercambiabili / Replaceable optical accessories



28-4139-100
Cilindro oro satinato
Satinated gold baffle



28-4139-31
Cilindro bianco
White baffle



28-4163-30
Frangiluce alveolare
Honeycomb



28-4073-61
Vetro sabbiato (solo per 9W e 12W)
Frosted glass (only for 9W e 12W)



28-4073-103
Vetro ellittico
Elliptical spread lens

Accessori ottici intercambiabili / Replaceable optical accessories



28-4139-100
Cilindro oro satinato
Satinated gold baffle



28-4163-30
Frangiluce alveolare
Honeycomb



28-4073-61
Vetro sabbiato (solo per 9W e 12W)
Frosted glass (only for 9W e 12W)



28-4073-103
Vetro ellittico
Elliptical spread lens

MICROPERFETTO LARGE - R CON LENTE / WITH LENS



21 Bianco mat
Mat white

16 Nero
Black

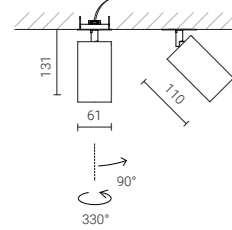

h 50 mm
Ø 55 mm
0,1 Kg

Codice Code	LED Lumen	Product Lumen	Watt	mA	Colour T (K)	CRI	Fascio Beam
Con lente in silicone e rosone per applicazione a incasso With silicone lens and canopy for recessed application							
785-279BZN	1760	1496	18,5	500	3000	90	15°
785-279BYN	2760	2346	25	700	3000	90	24°
	3100	2635	29	800	3000	90	24°
785-279CZN	1630	1386	18,5	500	2700	90	15°
785-279CYN	2650	2253	25	700	2700	90	24°
	2980	2533	29	800	2700	90	24°

Driver da ordinare separatamente / Driver should be ordered separately

81-04011	Output 500mA
81-04002	Output 500mA Dimmerabile DALI / DALI dimmable
81-04067	Output 700mA Dimmerabile DALI / DALI dimmable
81-04068	Output 700mA Dimmerabile 1-10V / 1-10V dimmable
81-04069	Output 800mA
81-04070	Output 800mA Dimmerabile DALI / DALI dimmable
81-04071	Output 800mA Dimmerabile 1-10V / 1-10V dimmable

CE IP20

MICROPERFETTO LARGE - R ZOOM



21 Bianco mat
Mat white

16 Nero
Black

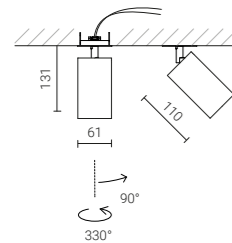

h 50 mm
Ø 55 mm
0,1 Kg

Codice Code	LED Lumen	Product Lumen	Watt	mA	Colour T (K)	CRI	Fascio Beam
Con lente zoom regolabile in 7 posizioni e rosone per applicazione a incasso With zoom lens adjustable in 7 positions and canopy for recessed application							
784-179BN	1310	1114	18,5	500	3000	90	13° to 47°
784-179CN	1216	1034	18,5	500	2700	90	13° to 47°

Driver da ordinare separatamente / Driver should be ordered separately

81-04011	Output 500mA
81-04002	Output 500mA Dimmerabile DALI / DALI dimmable

CE IP20

Zoom technology

La rotazione del cilindro interno permette di modificare l'angolo del fascio da 13° a 47°.

The rotation of the internal snoot modifies the beam angle from 13° to 47°.

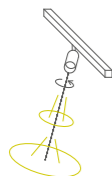

MICROPERFETTO LARGE BASE ZOOM

Proiettori da semi-incasso e superficie Semi-recessed/surface spotlights

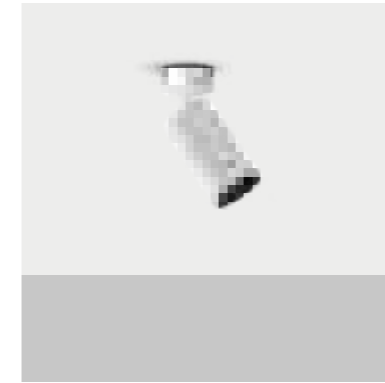

21 Bianco mat
Mat white

16 Nero
Black

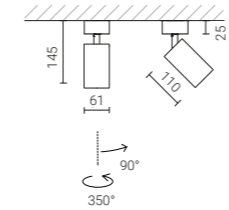

0,5 Kg

Codice Code	LED Lumen	Product Lumen	Watt	mA	Colour T (K)	CRI	Fascio Beam
Con lente zoom regolabile in 7 posizioni e basetta per applicazione a superficie With zoom lens adjustable in 7 positions and base for surface application							
784-129BN	1310	1114	18,5	500	3000	90	13° to 47°
784-129CN	1216	1034	18,5	500	2700	90	13° to 47°

Driver da ordinare separatamente / Driver should be ordered separately

81-04011	Output 500mA
81-04002	Output 500mA Dimmerabile DALI / DALI dimmable

CE IP20

Zoom technology

La rotazione del cilindro interno permette di modificare l'angolo del fascio da 13° a 47°.

The rotation of the internal snoot modifies the beam angle from 13° to 47°.

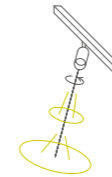

MINIPERFETTO BASE



Codice Code	LED Lumen	Product Lumen	Watt	Colour T (K)	CRI	Fascio Beam
Con basetta per applicazione a superficie, con driver integrato With base for surface application, with integrated driver						
748-129	1170	972	9	3000	90	30°
748-129BV	1170	972	9	3000	90	45°
748-129C	1100	915	9	2700	90	30°
748-129CV	1100	915	9	2700	90	45°

Regolabile sulla fase / Dimmable on the mains
220/240V - 50/60Hz

21 Bianco mat
Mat white

16 Nero
Black

CE IP20

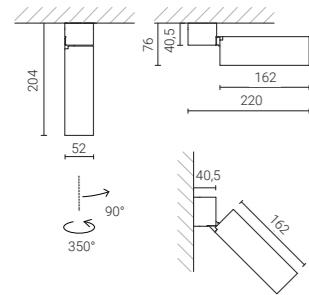

0,6 Kg



Miniperfetto Base
Abitazione privata (Roma) – Private residence (Rome)

Accessori ottici intercambiabili / Replaceable optical accessories



28-3979-100
Cilindro oro satinato
Satined gold baffle



28-4536-30
Frangiluce alveolare
Honeycomb

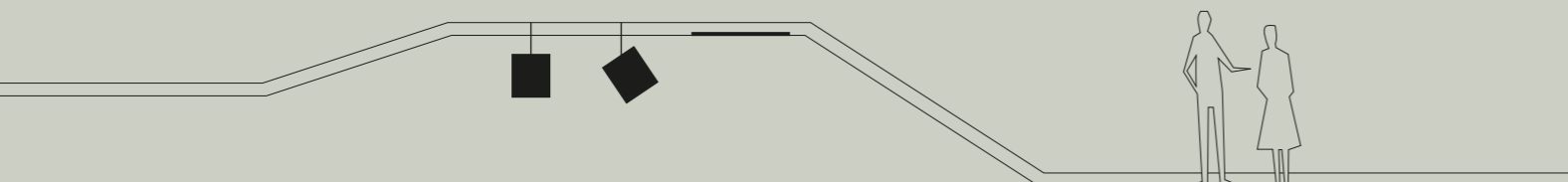

Una luce morbida, in forma flessibile

A soft light, in a flexible form

^{ITA} Caratterizzati da forme miniaturizzate, cilindriche e geometriche, sono progettati per soddisfare innumerevoli esigenze progettuali. Il design e le finiture strizzano l'occhio a contesti nei quali è richiesto non solo un apporto illuminotecnico performante, ma anche un'eleganza e stile, elementi che, di certo, non mancano ai prodotti di questa gamma.

^{EN} They can solve countless design needs, thanks to their miniaturized, cylindrical, and geometric shapes. The design and finishes wink at contexts in which not only a high-performance lighting contribution is needed but also elegance and style. Elements that, of course, are not lacking in the products in this range.



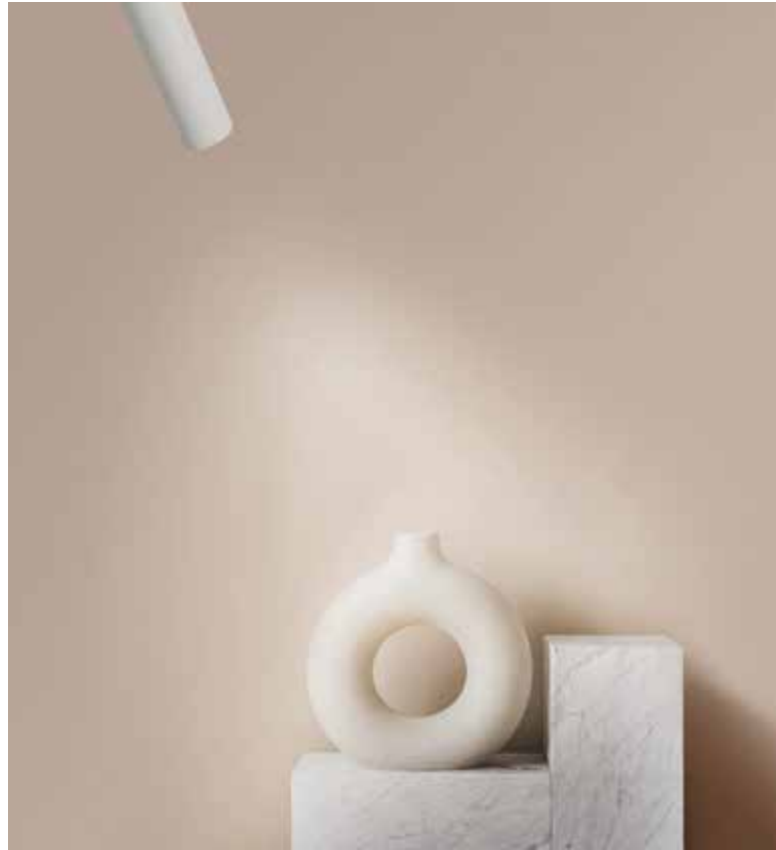

IT Gli accessori ottici disponibili per la gamma di proiettori Aria trasformano gli apparecchi in strumenti di luce multifunzionali, ideali per esigenze progettuali diverse.

La puntuale luce d'accento fornita da questi prodotti enfatizza e valorizza oggetti e finiture.

EN The optical accessories available for the Aria range of projectors transform the luminaires into multifunctional lighting tools, ideal for different design needs.

The precise accent light provided by these products emphasizes and enhances objects and finishes.



ITA Nano, Micro e Mini sono proiettori Perfetto, dalle dimensioni miniaturizzate, che presentano eccellente flessibilità, massima efficienza e grande controllo dell'abbagliamento. Linea 48, installato nei binari 48Vdc, è la soluzione ottimale per dare vita a vere e proprie linee di luce continue sulla parete e sul soffitto, creando scenografie sempre diverse.

EN Nano, Micro and Mini are Perfetto projectors, with miniature dimensions, which offer excellent flexibility, maximum efficiency, and great glare control. Linea 48, mounted in the 48Vdc tracks, is the best solution to create continuous lines of lights on the walls or in the ceiling, providing possibilities for a multitude of light scenes.



Linee di luce diffusa per l'architettura

Lines of diffused light for architecture

^{ITA} Linea 48 è una linea di luce da installare nei binari elettrificati 48Vdc a bassa tensione. È la soluzione ottimale per dare vita a vere e proprie linee di luce continue sulla parete e sul soffitto, creando scenografie sempre diverse. È fornita con schermo in policarbonato opale satinato ed è disponibile in tre lunghezze, due finiture e diverse temperature di colore.

^{EN} Linea 48 is a line of light to be mounted in the 48Vdc low voltage electrified tracks. It is the best solution to create continuous lines of lights on the walls or in the ceiling, providing possibilities for a multitude of light scenes. It is provided with an opal frosted polycarbonate screen and it is available in three lengths, two body finishes and with different colour temperatures.



^{ITA} Minirooler, applicabile su binari 48Vdc a bassa tensione e su 35 Track, è caratterizzato da una grande efficienza racchiusa in solo 14 mm di larghezza. Minirooler prevede 15 lenti in PMMA per differenti aperture, oltre alla possibilità di ottenere fasci asimmetrici. La quasi invisibilità delle sorgenti luminose all'interno dell'apparecchio focalizza l'attenzione sui dettagli dell'architettura e genera comfort visivo assoluto, senza abbagliamento.

^{EN} Minirooler can be mounted on 48Vdc low voltage tracks and on 35 Track. It features a high efficiency enshrined in only 14 mm length. Minirooler features 15 PMMA lenses that allow for different light beams also for asymmetric effects. The light sources are almost invisible within the fitting so that the attention is focused on the details of the architecture only, for a great visual comfort without glaring.



Oru Hub Hotel – Tallin

Linea 48 in finitura nera in combinazione con la luce d'accento dei proiettori Microperferetto 48Voc.
Linea 48 black finish combined with the accent light of Microperferetto 48Voc spotlights.



MV Agusta Flagship Store – Roma
Miniperfetto LKM

Estetica essenziale per luce d'accento

Essential design for accent light

^{ITA} Proiettori LKM, come Perfetto Puro e il Perfetto Compact, sono ideali per quei contesti, come il retail, dove un elevato apporto di luce è caratteristica che può fare la differenza. In ambienti di questo tipo, infatti, ciò che è necessario valorizzare non è solo lo store, come nel caso dei progetti negli scatti, ma anche i prodotti esposti che, ovviamente, acquistano maggior valore per il cliente se esaltati dalla giusta luce.

Boma è modello di design depositato e modello di utilità brevettato. Design: Enrico Davide Bona e Elisa Nobile.

^{EN} LKM spotlights, such as Perfetto Puro and Perfetto Compact, are ideal for retail contexts where a high amount of light is a feature that can make the difference. In fact, in these spaces, not only the store should be promoted, but also the displayed products that obviously acquire a greater value for the customer if enhanced by the right light.

Boma is a registered design model and it is patented as utility model. Design: Enrico Davide Bona and Elisa Nobile.



Fred Perry Flagship Store – Milano
Perfetto Puro LKM



Installazione su 35 Track

35 Track installation

^{ITA} 35 Track permette l'integrazione delle famiglie di micro-proiettori e luci lineari caratterizzati da design minimale, basso abbagliamento e ottiche simmetriche ed asimmetriche. L'accensione upright di 35 Track combinata con i fasci più stretti dei proiettori permette di ottenere effetti di luce flessibili.

^{EN} 35 Track allows the integration of families of micro-spotlights and linear lights characterized by minimal design, low glare, and symmetrical and asymmetrical optics. The upright of 35 Track combined with the narrower beams of the spotlights gives life to flexible lighting effects.



La luce al tuo servizio

Light at your service

^{ITA} Alcuni proiettori sono equipaggiati con lente zoom. La rotazione dello snoot integrato in sette posizioni differenti modifica il fascio da 13° a 47°. Questo consente di poter modificare arredi, installazioni, esposizioni senza dover sostituire gli apparecchi di illuminazione.

^{EN} Some spotlights feature a zoom lens. The rotation of the integrated snoot in seven different positions changes the beam from 13° to 47°. This movement allows you to change furnishings, installations, and exhibitions without replacing the lighting fixtures.

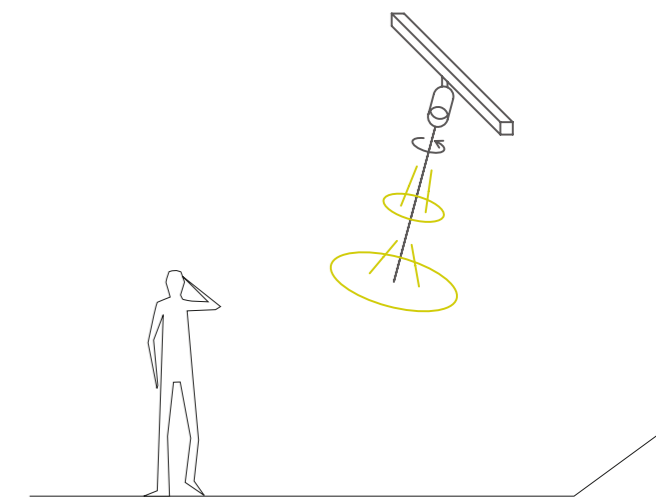

Zoom technology

beam / fascio

13° → 47°

















Luci a binario

Track lights



INDEX

Products	Pages
 Nanoperfetto 48V_{DC}	130
 Microperfetto Low 48V_{DC}	132
 Microperfetto 48V_{DC}	133
 Microperfetto Large 48V_{DC} / Microperfetto Large 48V_{DC} Zoom	134
 Minirooler 48V_{DC}	136
 Linea 48V_{DC}	137
 Microperfetto LKM	138
 Microperfetto Large LKM with lens	139
 Microperfetto Large LKM	140
 Microperfetto Large LKM Zoom	141
 Miniperfetto LKM / Miniperfetto MM	142
 Perfetto Compact	143
 Perfetto Box	144
 Perfetto Puro	145
 Boma LED	146

NANOPERFETTO 48V_{DC}
CON LENTE / WITH LENS



21 Bianco mat
Mat white

16 Nero
Black

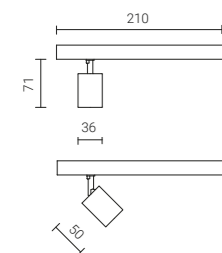

0,3 Kg

Codice Code	LED Lumen	Product Lumen	Watt	Colour T (K)	CRI	Fascio Beam
-------------	-----------	---------------	------	--------------	-----	-------------

Dimmerabile PWM per binari elettrificati a bassa tensione 48V_{DC} - con lente in PMMA
PWM dimmable for 48V_{DC} low-voltage electrified tracks with PMMA lens

752-789C	675	581	7,3	2700	90	21°
752-789CW	675	581	7,3	2700	90	38°
752-789	713	613	7,3	3000	90	21°
752-789BW	713	613	7,3	3000	90	38°

Con driver DALI integrato - utilizzare con apposito trasformatore DALI
With integrated DALI driver - to be used with proper DALI transformer

752-889C	675	581	7,3	2700	90	21°
752-889CW	675	581	7,3	2700	90	38°
752-889	713	613	7,3	3000	90	21°
752-889BW	713	613	7,3	3000	90	38°

Sistema Dim to Warm / Dim to Warm system

752-1089M	494*	420	5	1800-2700 Dim to Warm	90	21°
752-1089MW	494*	420	5	1800-2700 Dim to Warm	90	38°

* Valore riferito alla massima dimmerabile / Value referring to max dimming

48V_{DC}

CE IP20

Trasformatore elettronico per uso remoto e dimmer PWM o DALI dedicato, da ordinare separatamente / Electronic transformer for remote use and proper PWM or DALI dimmer, to be ordered separately



Nanoperfetto 48V_{DC} + Nanoperfetto-R

MICROPERFETTO LOW 48V_{dc}



21 Bianco mat
Mat white

16 Nero
Black

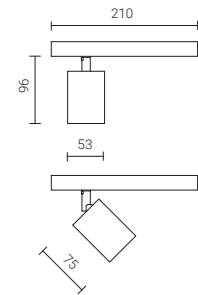

0,4 Kg

Codice Code	LED Lumen	Product Lumen	Watt	Colour T (K)	CRI	Fascio Beam
-------------	-----------	---------------	------	--------------	-----	-------------

Dimmerabile PWM per binari elettrificati a bassa tensione 48V_{dc} - con vetro zigrinato
PWM dimmable for 48V_{dc} low-voltage electrified tracks - with prismatic spread lens

753-689CZ	1946	1362	18	2700	90	16°
753-689C	1946	1362	18	2700	90	30°
753-689BZ	2051	1436	18	3000	90	16°
753-689	2051	1436	18	3000	90	30°

Con driver DALI integrato - utilizzare con apposito trasformatore DALI
With integrated DALI driver - to be used with proper DALI transformer

753-789CZ	1946	1362	18	2700	90	16°
753-789C	1946	1362	18	2700	90	30°
753-789BZ	2051	1436	18	3000	90	16°
753-789	2051	1436	18	3000	90	30°

48V_{dc}



Trasformatore elettronico per uso remoto e dimmer PWM o DALI dedicato, da ordinare separatamente / Electronic transformer for remote use and proper PWM or DALI dimmer, to be ordered separately

MICROPERFETTO 48V_{dc}



21 Bianco mat
Mat white

16 Nero
Black

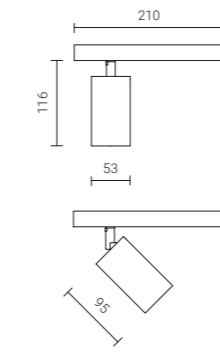

0,4 Kg

Codice Code	LED Lumen	Product Lumen	Watt	Colour T (K)	CRI	Fascio Beam
-------------	-----------	---------------	------	--------------	-----	-------------

Dimmerabile PWM per binari elettrificati a bassa tensione 48V_{dc} - con vetro zigrinato
PWM dimmable for 48V_{dc} low-voltage electrified tracks with prismatic spread lens

754-789C	2590	1813	26	2700	90	30°
754-789CV	2590	1813	26	2700	90	45°
754-789	2700	1890	26	3000	90	30°
754-789BV	2700	1890	26	3000	90	45°

Con driver DALI integrato - utilizzare con apposito trasformatore DALI
With integrated DALI driver - to be used with proper DALI transformer

754-889C	2590	1813	26	2700	90	30°
754-889CV	2590	1813	26	2700	90	45°
754-889	2700	1890	26	3000	90	30°
754-889BV	2700	1890	26	3000	90	45°

48V_{dc}



Sistema Dim to Warm / Dim to Warm system

754-689	1130*	791	12	1800-2700 Dim to Warm	90	30°
---------	-------	-----	----	--------------------------	----	-----

*Valore riferito alla massima dimmerazione / Value referring to max dimming

48V_{dc}



Trasformatore elettronico per uso remoto e dimmer PWM o DALI dedicato, da ordinare separatamente / Electronic transformer for remote use and proper PWM or DALI dimmer, to be ordered separately

Accessori ottici intercambiabili / Replaceable optical accessories



28-4139-100
Cilindro oro satinato
Satined gold baffle



28-4139-31
Cilindro bianco
White baffle



28-4163-30
Frangiluce alveolare
Honeycomb



28-4073-103
Vetro ellittico
Elliptical spread lens

Accessori ottici intercambiabili / Replaceable optical accessories



28-4139-100
Cilindro oro satinato
Satined gold baffle



28-4139-31
Cilindro bianco
White baffle



28-4163-30
Frangiluce alveolare
Honeycomb



28-4073-61
Vetro sabbato
Frosted glass



28-4073-103
Vetro ellittico
Elliptical spread lens

MICROPERFETTO LARGE 48V_{dc}
CON LENTE / WITH LENS



Codice Code	LED Lumen	Product Lumen	Watt	Colour T (K)	CRI	Fascio Beam
Dimmerabile PWM per binari elettrificati a bassa tensione 48V _{dc} - con lente in silicone PWM dimmable for 48V _{dc} low-voltage electrified tracks - with silicone lens						
795-189C	1630	1386	18,5	2700	90	15°
795-189B	1760	1496	18,5	3000	90	15°
795-389C	2650	2253	25	2700	90	24°
795-389B	2760	2346	25	3000	90	24°

48V_{dc}

21 Bianco mat
Mat white

16 Nero
Black



Trasformatore elettronico per uso remoto e dimmer PWM o DALI dedicato,
da ordinare separatamente / Electronic transformer for remote use and proper
PWM or DALI dimmer, to be ordered separately

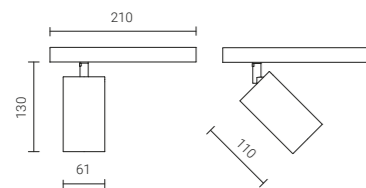

0.5 Kg

MICROPERFETTO LARGE 48V_{dc}
ZOOM



Codice Code	LED Lumen	Product Lumen	Watt	Colour T (K)	CRI	Fascio Beam
Dimmerabile PWM per binari elettrificati a bassa tensione 48V _{dc} - con lente zoom regolabile in 7 posizioni / PWM dimmable for 48V _{dc} low-voltage electrified tracks - with zoom lens adjustable in 7 positions.						
794-189C	1630	1386	18,5	2700	90	13° to 47°
794-189B	1760	1496	18,5	3000	90	13° to 47°

48V_{dc}

21 Bianco mat
Mat white

16 Nero
Black



Trasformatore elettronico per uso remoto e dimmer PWM o DALI dedicato,
da ordinare separatamente / Electronic transformer for remote use and proper
PWM or DALI dimmer, to be ordered separately

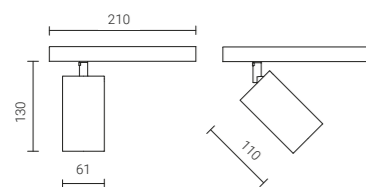

0.5 Kg

Zoom technology

La rotazione del cilindro interno
permette di modificare l'angolo
del fascio da 13° a 47°.

The rotation of the internal snoot
modifies the beam angle from
13° to 47°.

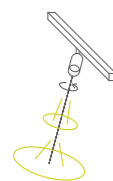

Microperpetto Large Zoom 48V_{dc}
installazione su 35 Track / installation on 35 Track

MINIROOLER 48Vdc

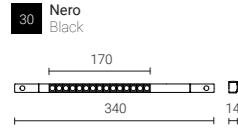

0,1 Kg

DALI

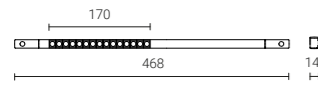

0,1 Kg

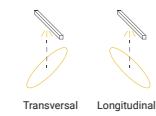

Codice Code	LED Lumen	Product Lumen	Watt	Colour T (K)	CRI	Fascio Beam
Dimmerabile PWM per binari a bassa tensione 48Vdc - con 15 microlenti in PMMA. PWM dimmable for 48Vdc low-voltage electrified tracks with 15 PMMA microlenses.						
471-019CZ	1650	1337	17	2700	90	12°
471-019CY	1650	1139	17	2700	90	20°
471-019CW	1650	1320	17	2700	90	50°
471-019CR	1650	1139	17	2700	90	14° + 41° transversal
471-019CQ	1650	1139	17	2700	90	14° + 41° longitudinal
471-019BZ	1650	1337	17	3000	90	12°
471-019BY	1650	1139	17	3000	90	20°
471-019BW	1650	1320	17	3000	90	50°
471-019BR	1650	1139	17	3000	90	14° + 41° transversal
471-019BQ	1650	1139	17	3000	90	14° + 41° longitudinal

Trasformatore elettronico per uso remoto e dimmer PWM dedicato, da ordinare separatamente
Electronic transformer for remote use and proper PWM dimmer, to be ordered separately

Con driver DALI integrato - utilizzare con apposito trasformatore DALI
With integrated DALI driver - to be used with proper DALI transformer

472-019CZ	1650	1337	17	2700	90	12°
472-019CY	1650	1139	17	2700	90	20°
472-019CV	1650	1320	17	2700	90	50°
472-019CR	1650	1139	17	2700	90	14° + 41° transversal
472-019CQ	1650	1139	17	2700	90	14° + 41° longitudinal
472-019BZ	1650	1337	17	3000	90	12°
472-019BY	1650	1139	17	3000	90	20°
472-019BV	1650	1320	17	3000	90	50°
472-019BR	1650	1139	17	3000	90	14° + 41° transversal
472-019BQ	1650	1139	17	3000	90	14° + 41° longitudinal

48Vdc

CE IP40

LINEA 48Vdc

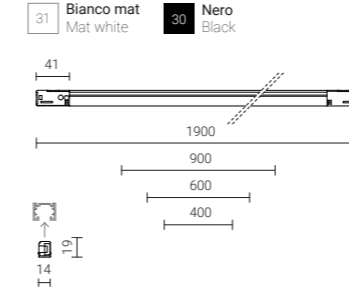

31 Bianco mat Mat white 30 Nero Black

Codice Code	Lunghezza Length (mm)	LED Lumen	Product Lumen	Watt	Colour T (K)	CRI
Dimmerabile PWM per binari a bassa tensione 48Vdc - con schermo in policarbonato opale satinato / PWM dimmable for 48Vdc low-voltage electrified tracks with opal frosted polycarbonate screen						
470-01906	600	650	-	5	3000	90
470-07906	600	1292	-	12	3000	90
470-08909	900	2068	-	19	3000	90
470-02909	900	1040	-	8	3000	90
470-03919	1900	2340	-	18	3000	90

48Vdc

CE IP20

Trasformatore elettronico per uso remoto e dimmer PWM dedicato, da ordinare separatamente / Electronic transformer for remote use and proper PWM dimmer, to be ordered separately

MICROPERFETTO LKM



Codice Code	LED Lumen	Product Lumen	Watt	Colour T (K)	CRI	Fascio Beam
Per binari elettrificati trifase LKM - con vetro zigrinato For LKM three-phase electrified tracks - with prismatic spread lens						
760-169C	2590	1813	26	2700	90	30°
760-169CV	2590	1813	26	2700	90	45°
760-169B	2700	1890	26	3000	90	30°
760-169BV	2700	1890	26	3000	90	45°
760-169A	2740	1918	26	4000	90	30°
760-169AV	2740	1918	26	4000	90	45°
220/240V - 50/60Hz						

21 Bianco mat Mat white 16 Nero Black

CE IP20

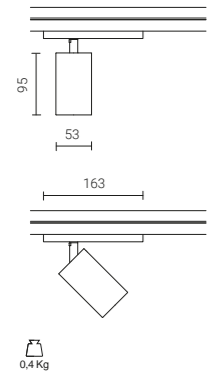

MICROPERFETTO LARGE LKM CON LENTE / WITH LENS



Codice Code	LED Lumen	Product Lumen	Watt	Colour T (K)	CRI	Fascio Beam
Per binari elettrificati trifase LKM - con lente in silicone For LKM three-phase electrified tracks - with silicone lens						
779-169C	1630	1386	18,5	2700	90	15°
779-169B	1760	1496	18,5	3000	90	15°
779-269C	2980	2533	29	2700	90	24°
779-269B	3100	2635	29	3000	90	24°
Con driver DALI - per binari dimmerabili DKM con apposito adattatore - con lente in silicone With DALI driver - for DKM dimmable tracks with proper adapter - with silicone lens						
782-169C	1630	1386	18,5	2700	90	15°
782-169B	1760	1496	18,5	3000	90	15°
782-269C	2980	2533	29	2700	90	24°
782-269B	3100	2635	29	3000	90	24°
220/240V - 50/60Hz						

21 Bianco mat Mat white 16 Nero Black

CE IP20

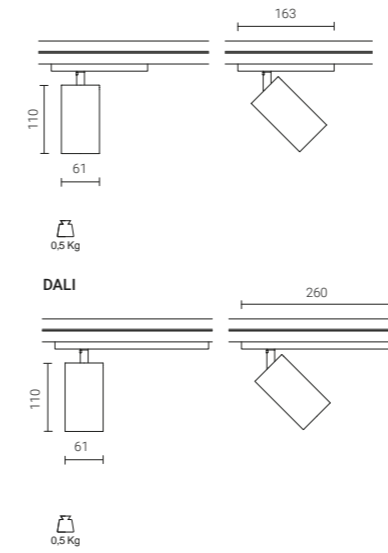

Accessori ottici intercambiabili / Replaceable optical accessories



28-4139-100
Cilindro oro satinato
Satined gold baffle



28-4163-30
Frangiluce alveolare
Honeycomb



28-4073-61
Vetro sabbiato
Frosted glass



28-4073-103
Vetro ellittico
Elliptical spread lens

MICROPERFETTO LARGE LKM



21 Bianco mat
Mat white

16 Nero
Black

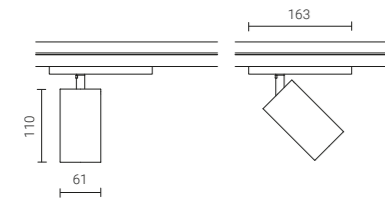

0.5 Kg

DALI

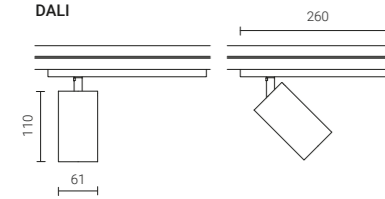

0.5 Kg

Codice Code	LED Lumen	Product Lumen	Watt	Colour T (K)	CRI	Fascio Beam
-------------	-----------	---------------	------	--------------	-----	-------------

Per binari elettrificati trifase LKM
For LKM three-phase electrified tracks

780-369CY	2650	2120	25	2700	90	20°
780-369C	2650	2120	25	2700	90	30°
780-369CW	2650	2120	25	2700	90	42°

780-369BY	2760	2208	25	3000	90	20°
780-369B	2760	2208	25	3000	90	30°
780-369BW	2760	2208	25	3000	90	42°

780-269CY	2980	2384	29	2700	90	20°
780-269C	2980	2384	29	2700	90	30°
780-269CW	2980	2384	29	2700	90	42°

780-269BY	3100	2480	29	3000	90	20°
780-269B	3100	2480	29	3000	90	30°
780-269BW	3100	2480	29	3000	90	42°

Con driver DALI - per binari dimmerabili DKM con apposito adattatore
With DALI driver - for DKM dimmable tracks with proper adapter

783-269CY	2980	2384	29	2700	90	20°
783-269C	2980	2384	29	2700	90	30°
783-269CW	2980	2384	29	2700	90	42°

783-269BY	3100	2480	29	3000	90	20°
783-269B	3100	2480	29	3000	90	30°
783-269BW	3100	2480	29	3000	90	42°

220/240V - 50/60Hz

CE IP20

MICROPERFETTO LARGE LKM ZOOM



21 Bianco mat
Mat white

16 Nero
Black

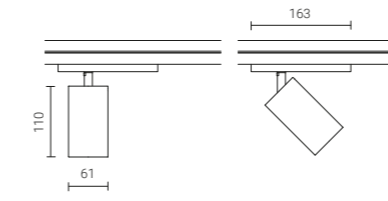

0.5 Kg

DALI

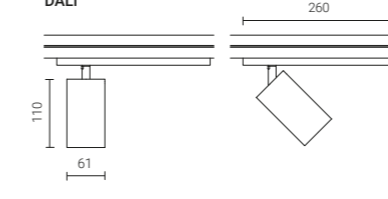

0.5 Kg

Codice Code	LED Lumen	Product Lumen	Watt	Colour T (K)	CRI	Fascio Beam
-------------	-----------	---------------	------	--------------	-----	-------------

Per binari elettrificati trifase LKM - con lente zoom regolabile in 7 posizioni
For LKM three-phase electrified tracks - with zoom lens adjustable in 7 positions

778-169C	1630	1386	18,5	2700	90	13° to 47°
-----------------	------	------	------	------	----	------------

778-169B	1760	1496	18,5	3000	90	13° to 47°
-----------------	------	------	------	------	----	------------

Con driver DALI - per binari dimmerabili DKM con apposito adattatore
With DALI driver - for DKM dimmable tracks with proper adapter

781-169C	1630	1386	18,5	2700	90	13° to 47°
-----------------	------	------	------	------	----	------------

781-169B	1760	1496	18,5	3000	90	13° to 47°
-----------------	------	------	------	------	----	------------

220/240V - 50/60Hz

CE IP20

Zoom technology

La rotazione del cilindro interno permette di modificare l'angolo del fascio da 13° a 47°.

The rotation of the internal snoot modifies the beam angle from 13° to 47°.

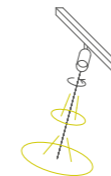

Accessori ottici intercambiabili / Replaceable optical accessories



28-4535-30
Frangiluce alveolare
Honeycomb



28-4534-47
Vetro zigrinato
Prismatic spread lens

MINIPERFETTO LKM



Codice Code	LED Lumen	Product Lumen	Watt	Colour T (K)	CRI	Fascio Beam
Per binari elettrificati trifase LKM For LKM three-phase electrified tracks						
748-2693C	1100	914	9	2700	90	30°
748-2693	1170	972	9	3000	90	30°
748-1693	1469	1221	12	3000	90	30°

9W: Regolabile sulla fase / Dimmable on the mains
220/240V - 50/60Hz

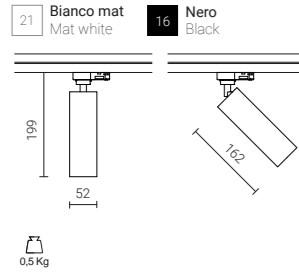

MINIPERFETTO MM



Codice Code	LED Lumen	Product Lumen	Watt	Colour T (K)	CRI	Fascio Beam
Per binari elettrificati monofase MM For MM single-phase electrified tracks						
748-2592	1170	972	9	3000	90	30°
748-1592	1469	1221	12	3000	90	30°
748-1592A	1500	1247	12	4000	90	30°

9W: Regolabile sulla fase / Dimmable on the mains
220/240V - 50/60Hz

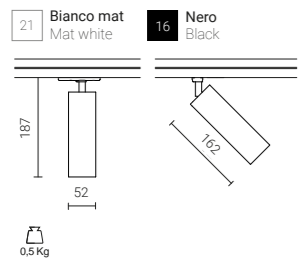

Accessori ottici intercambiabili / Replaceable optical accessories

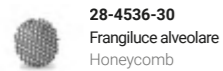

28-4536-30
Frangiluce alveolare
Honeycomb



28-3979-100
Cilindro oro satinato
Satinated gold baffle

PERFETTO COMPACT



Codice Code	LED Lumen	Product Lumen	Watt	Colour T (K)	CRI	Fascio Beam
Per binari elettrificati trifase LKM For LKM three-phase electrified tracks						
751-1613BYMD	2400	1750	18	3000	85	20°
751-1613MD	2400	1750	18	3000	85	29°
751-1613BWMD	2400	1750	18	3000	85	42°
751-2613BY	3125	2278	26	3000	85	20°
751-2613	3125	2278	26	3000	85	29°
751-2613BW	3125	2278	26	3000	85	42°
751-3613BY	3500	2552	30	3000	85	20°
751-3613	3500	2552	30	3000	85	29°
751-3613BW	3500	2552	30	3000	85	42°

Con driver DALI - per binari dimmerabili DKM con apposito adattatore
With DALI driver - for DKM dimmable tracks with proper adapter

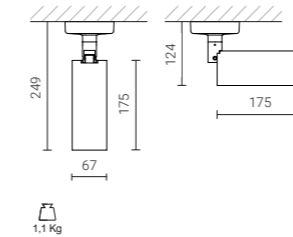
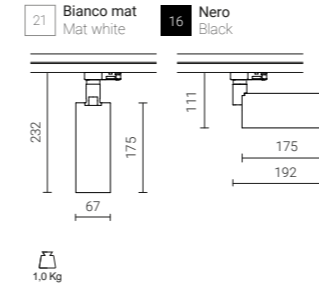

Con base / With base

751-221	3125	2278	26	3000	85	29°
----------------	------	------	----	------	----	-----

18W: Regolabile sulla fase / Dimmable on the mains
220/240V - 50/60Hz



Accessori ottici intercambiabili / Replaceable optical accessories



28-9004-30
Cilindro antiabbagliamento
Snoot



28-4080-30
Frangiluce alveolare (da utilizzare insieme a snoot cod. 28-9004-30)
Honeycomb (to be used with snoot code 28-9004-30)



28-3905-47
Schermo di chiusura in termoplastico trasparente
Closing screen in clear thermoplastic material

PERFETTO BOX



Codice Code	LED Lumen	Product Lumen	Watt	Colour T (K)	CRI	Fascio Beam
Per binari elettrificati trifase LKM For LKM three-phase electrified tracks						
743-2693	4000	3560	33	3000	90	30°
743-4613	5550	4940	43	3000	85	30°
Con driver DALI - per binari dimmerabili DKM con apposito adattatore With DALI driver - for DKM dimmable tracks with proper adapter						
747-469	4500	4005	43	3000	90	30°
220/240V - 50/60Hz						

21 Bianco mat Mat white 16 Nero Black

CE IP20

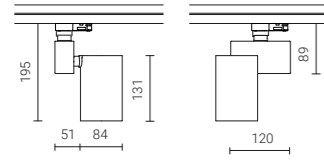

1.7 Kg

DALI

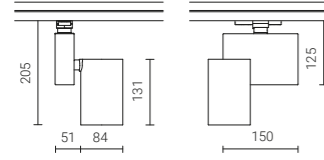

1.8 Kg

Accessori ottici intercambiabili / Replaceable optical accessories



28-3957-30
Cilindro antiabbagliamento
Snoot



28-3959-30
Frangiluce alveolare (da utilizzare insieme a snoot cod. 28-3957-30)
Honeycomb (to be used with snoot code 28-3957-30)

PERFETTO PURO



Codice Code	LED Lumen	Product Lumen	Watt	Colour T (K)	CRI	Fascio Beam
Per binari elettrificati trifase LKM For LKM three-phase electrified tracks						
770-061BZ	4400	3916	32	3000	85	17°
770-061	4400	3916	32	3000	85	30°
770-061BV	4400	3916	32	3000	85	55°
770-061BT	4400	3916	32	3000	85	70°
Con driver DALI - per binari dimmerabili DKM con apposito adattatore With DALI driver - for DKM dimmable tracks with proper adapter						
770-061AZ	4500	4005	32	4000	85	17°
770-061A	4500	4005	32	4000	85	30°
770-061AV	4500	4005	32	4000	85	55°
770-061AT	4500	4005	32	4000	85	70°
220/240V - 50/60Hz						

21 Bianco mat Mat white 16 Nero Black

CE IP20

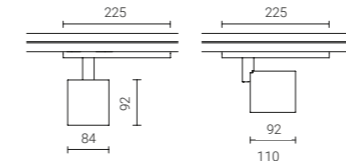

0.9 Kg

770-069BZ	3830	3409	32	3000	90	17°
770-069	3830	3409	32	3000	90	30°
770-069BV	3830	3409	32	3000	90	55°
770-069BT	3830	3409	32	3000	90	70°

770-261BZ	5000	4450	37	3000	85	17°
770-261	5000	4450	37	3000	85	30°
770-261BV	5000	4450	37	3000	85	55°
770-261BT	5000	4450	37	3000	85	70°

770-261AZ	5150	4583	37	4000	85	17°
770-261A	5150	4583	37	4000	85	30°
770-261AV	5150	4583	37	4000	85	55°
770-261AT	5150	4583	37	4000	85	70°

770-269BZ	4400	3916	37	3000	90	17°
770-269	4400	3916	37	3000	90	30°
770-269BV	4400	3916	37	3000	90	55°
770-269BT	4400	3916	37	3000	90	70°

Con driver DALI - per binari dimmerabili DKM con apposito adattatore
With DALI driver - for DKM dimmable tracks with proper adapter

771-069BZ	3830	3409	32	3000	90	17°
771-069	3830	3409	32	3000	90	30°
771-069BV	3830	3409	32	3000	90	55°
771-069BT	3830	3409	32	3000	90	70°

771-269BZ	4400	3916	37	3000	90	17°
771-269	4400	3916	37	3000	90	30°
771-269BV	4400	3916	37	3000	90	55°
771-269BT	4400	3916	37	3000	90	70°

220/240V - 50/60Hz

CE IP20

Accessori ottici intercambiabili / Replaceable optical accessories



28-3957-30
Cilindro antiabbagliamento
Snoot



28-3959-30
Frangiluce alveolare (da utilizzare insieme a snoot cod. 28-3957-30)
Honeycomb (to be used with snoot code 28-3957-30)



Codice Code	Lunghezza Length (mm)	LED Lumen	Product Lumen	Watt	Colour T (K)	CRI	Fascio Beam
-------------	-----------------------	-----------	---------------	------	--------------	-----	-------------

Per binari elettrificati trifase LKM
For LKM three-phase electrified tracks

453-1603	915	4000	2800	30	3000	80	110°
453-2603	1200	5000	3640	35	3000	80	110°

230/240V - 50/60Hz

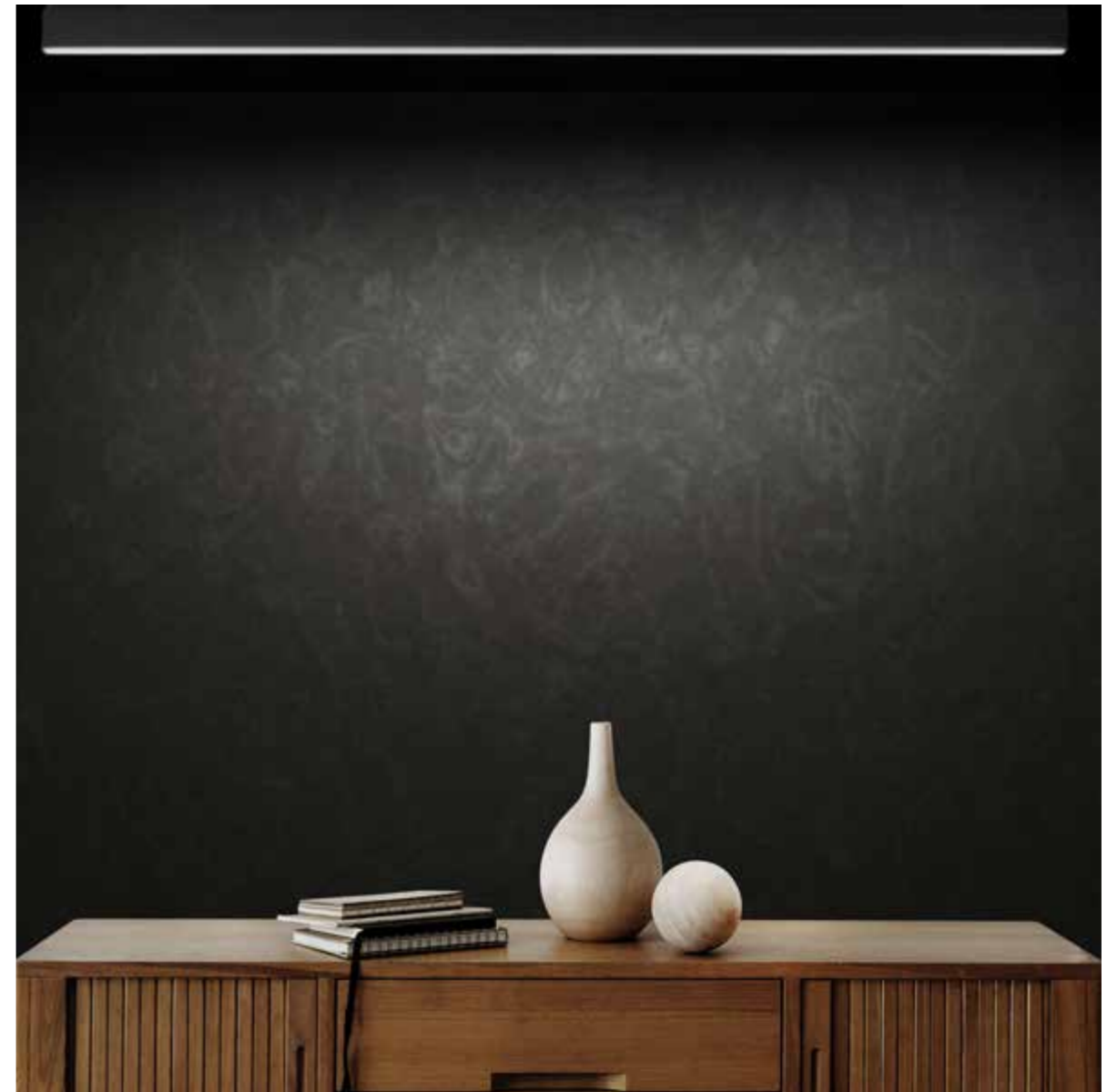
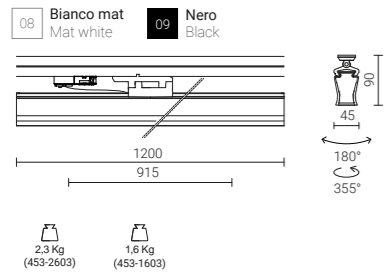

Boma LED

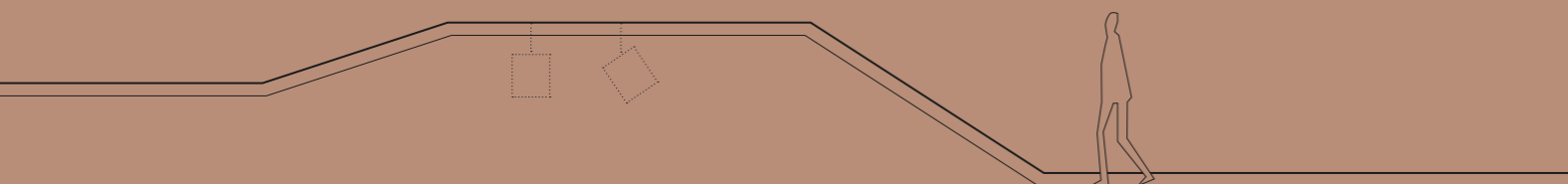

Linearità al servizio della creatività

Linearity at the service of creativity

^{IT} I binari sono progettati per essere facilmente installati a soffitto, a parete oppure incassati, per l'utilizzo di proiettori o apparecchi a sospensione. La semplicità di installazione degli apparecchi consente di avere impianti di illuminazione facilmente modificabili senza la necessità di interventi tecnici onerosi, così da creare scenari dinamici adattabili ai diversi ambienti.

^{EN} Tracks are designed to be easily installed, either on or recessed into the ceiling or wall and for use with spotlights or with suspended fittings. This easy and quick installation allows modification of the lighting layout at any time, avoiding expensive works and providing a dynamic solution that can fit in many different spaces.





^{ITA} La gamma di binari ARIA comprende binari dimmerabili, trifase, monofase e a bassa tensione, in grado di adattarsi in modo flessibile alle più svariate esigenze di illuminazione.

Caratteristiche Tecniche

I binari elettrificati sono costruiti in lega di alluminio estruso. I cavi conduttori in rame sono alloggiati all'interno di profilati estrusi in PVC ad alta resistenza di isolamento. Certificati dall'Istituto Italiano Marchio di Qualità (IMQ), sono conformi alle norme vigenti (EN 60570). I sistemi comprendono un'ampia varietà di accessori e di giunti di collegamento.

^{EN} The Ivela track range includes dimmable, three-phase, single-phase and low voltage tracks, able to fit with different lighting demands in a flexible way.

Technical Specifications

Electrified tracks are made of extruded aluminium alloy. The copper wires are located inside extruded PVC profiles with high insulating properties. They are certified by the Italian Quality Marking Institution (IMQ) and comply with current standards (EN 60570). A wide range of joints and accessories is available.



48V_{DC} / 48V_{DC}

^{ITA} I binari elettrificati a bassa tensione 48V_{DC} sono disponibili in tre differenti lunghezze e con diverse finiture di colore. I prodotti sono certificati dall'Istituto Italiano Marchio di Qualità (IMQ) e conformi alle normative vigenti (EN60570). La gamma di binari 48V_{DC} sono predisposti per montare i proiettori provvisti dello specifico adattatore.

^{EN} 48V_{DC} low voltage electrified are available in three different lengths and in different colours. They are certified by the Italian Quality Mark Institution (IMQ) and they comply with current Standards (EN 60570). The 48V_{DC} tracks range are compatible with spotlights equipped with the specific adapter.



Quadro / Square Incasso TL / TL recessed



DKM DIMMERABILE / DKM DIMMABLE

^{ITA} I binari DKM monofase permettono di gestire una varietà di applicazioni per la programmazione luminosa (DALI, DMX, 1-10V). Questa tecnologia consente, oltre a un consistente risparmio energetico, la possibilità di dar vita a scenografie luminose per ambienti espositivi, spazi polifunzionali e centri commerciali.

^{EN} The DKM tracks are applicable with the main systems in use to control light (DALI, DMX, 1-10V). This technology generates significant economies in terms of energy saving and it is ideal for exhibition areas, shopping and multifunctional centres.

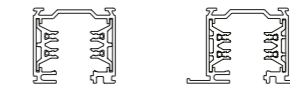

Quadro / Square Incasso / Recessed



LKM TRIFASE / LKM THREE-PHASE

^{ITA} Light Kit Main è un sistema di binari trifase per tre circuiti elettrici separati. Le tre varianti di sezione, tonda, quadra o da incasso, permettono un utilizzo in molteplici ambienti.

^{EN} Light Kit Main is a three-phase track system with 3 separate circuits. Three different designs (round, square or recessed) make the system highly versatile for a wide range of applications.

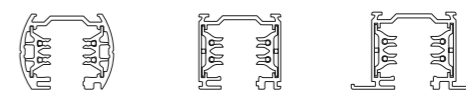

Tondo / Round Quadro / Square Incasso / Recessed



MM MONOFASE / MM SINGLE-PHASE

^{ITA} Mini Main è un sistema di binari monofase a una accensione, di facile installazione.

^{EN} Mini Main is a single-phase, single switch electrified track system, easy to install.





48V_{DC}

^{ITA} Binari elettrificati a bassa tensione 48V per applicazioni a soffitto, a parete, a sospensione e per installazioni a incasso trimless in controsoffitti. Predisposti per alloggiare i proiettori +e sospensioni provvisti di adattatore 48V, sono realizzati in lega di alluminio estruso, verniciato poliester. I due conduttori per 48V portano anche il segnale DALI, consentendo la regolazione dinamica della luce.

^{EN} 48V low voltage electrified tracks for ceiling, wall, suspension applications and for trimless recessed installations in false ceilings. They are compatible with spotlights and pendants equipped with 48V adapter. They are made of extruded aluminium alloy, polyester painted. The two 48V conductors can transmit also the DALI signal, allowing for the dynamic control of light.

Caratteristiche Tecniche

I binari elettrificati sono costruiti in lega di alluminio estruso. I cavi conduttori in rame sono alloggiati all'interno di profilati estrusi in PVC ad alta resistenza di isolamento. Certificati dall'Istituto Italiano Marchio di Qualità (IMQ), sono conformi alle norme vigenti (EN 60570).

Technical Specifications

Electrified tracks are made of extruded aluminium alloy. The copper wires are located inside extruded PVC profiles with high insulating properties. They are certified by the Italian Quality Marking Institution (IMQ) and they comply with current standards (EN 60570).

I sistemi comprendono un'ampia varietà di accessori e di giunti di collegamento.

Every system includes a wide range of joints and accessories.

Continuità del polo positivo (vista in planimetria dall'alto)
Continuity of the positive pole (top plan view)

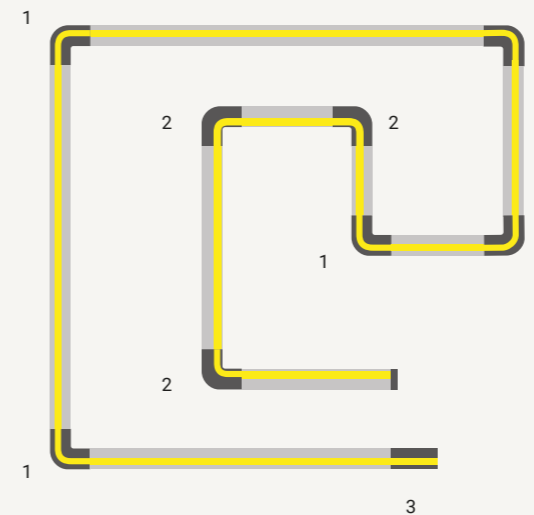

-  **1** Giunto L esterno
Outside L joint

-  **2** Giunto L interno
Inside L joint

-  **3** Alimentazione sinistra
Left live-end

^{ITA} **Capacità di Carico**

Il binario può sopportare un carico di 4 Kg ogni 1000 mm. Nel caso di carico di 4 Kg, ogni 200 mm, la distanza di fissaggio deve essere di 500 mm. Il carico massimo è di 720 W (48V_{DC} - 15 A).

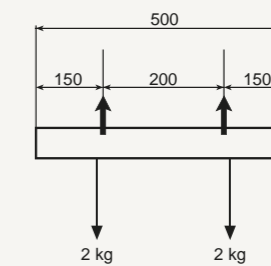

^{EN} **Load Capacity**

The track has a load capacity of 4 Kg every 1000 mm. For a 4 Kg load every 200 mm a maximum fixing distance of 500 mm is recommended. Maximum load is 720 W (48VDC - 15 A)

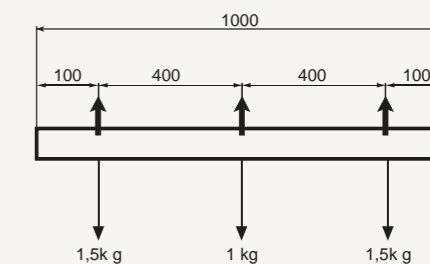

^{ITA} **Binario 48V Polarizzato**

Per una corretta installazione di tutti gli accessori che concorrono alla formazione di un impianto di binari 48V, è importante seguire la continuità della linea di positivo tra ogni elemento.

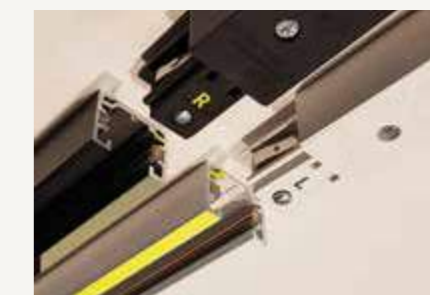

Alimentazione destra R
Right live-end R

Alimentazione sinistra L
Left live-end L

^{EN} **Polarized 48V Track**

The continuity of the positive line between each element is important for a correct installation of all the accessories in a 48V track composition.



Schemi di dimmerazione scaricabili dal sito

Dimming schemes can be downloaded from the web site



DKM

ITA Il binario monofase dimmerabile DKM è disponibile in differenti lunghezze per applicazioni a plafone, a sospensione e a incasso. Il binario DKM è idoneo per l'applicazione dei principali sistemi di programmazione luminosa (DALI, DMX, 1-10V). Alimentazione alla rete monofase 230-250V, carico complessivo di 16A corrispondente a 3680/4000W. Sono disponibili proiettori con driver DALI e appositi adattatori per binari dimmerabili DKM.

EN The single-phase dimmable track DKM is available in different lengths for installation on the ceiling, suspended or recessed. The DKM track is applicable with the main systems in use to control light (DALI, DMX, 1-10V). Connection to single phase 230-250V mains, total load of 16A corresponding to 3680/4000W. Spotlights including DALI drivers and specific adapters are available for DKM dimmable tracks.



ITA LUCE DINAMICA

La possibilità di gestire, da un sistema remoto, l'intensità dei flussi luminosi di ogni singolo punto luce in modo indipendente consente un elevato livello di personalizzazione e di valorizzazione delle aree espositive. I sistemi di controllo dell'illuminazione consentono un reale miglioramento dell'efficienza energetica e permettono di creare scenografie della luce in diverse applicazioni, quali ambienti espositivi, musei, centri commerciali.

EN DYNAMIC LIGHT

Remote light control for the variation of the light intensity of each fitting in an independent way allows both a high level of customization and the right emphasis in exhibition areas. Light control systems make it possible to achieve real improvements in terms of energetic efficiency and to create scenic effects with light for different applications such as exhibition areas, museums, shopping centres.

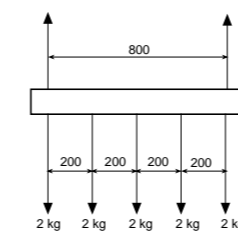

CAPACITÀ DI CARICO
LOAD CAPACITY

ITA Il binario può sopportare un carico di 2 Kg ogni 200 mm. Nel caso di carico di 10 Kg ogni 200 mm, la distanza di fissaggio deve essere di 400 mm.

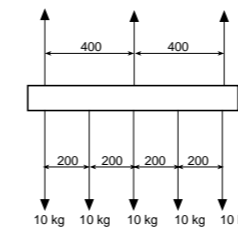

EN The track has a load capacity of 2 Kg every 200 mm. In case of 10 Kg load every 200 mm, a distance of 400 mm between the fixing points is recommended.

ITA SCHEMA ELETTRICO

Il collegamento alla rete elettrica monofase 230/250V consente un carico complessivo di 16A che corrisponde a 3680/4000 Watt.

EN WIRING DIAGRAM

Connection to single phase 230/250V mains allows a total load of 16A corresponding to 3680/4000W.

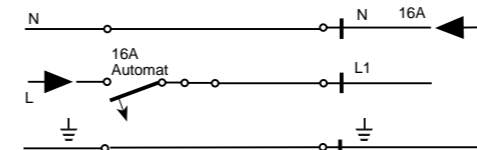

ITA ACCESSORI

Il binario DKM è corredato da una serie di accessori dedicati (adattatore e connettori di alimentazione), e di altri in comune con il sistema quadro LKM. È obbligatorio l'uso dello specifico adattatore elettromeccanico cod. 7559.

EN ACCESSORIES

The DKM track system includes a range of specific accessories such as an adapter and live-ends, together with a set of other accessories, that are in common with the LKM square system. The use of the specific electro-mechanic adapter code 7559 is compulsory.





LKM

ITA accensioni, disponibile in quattro lunghezze per applicazioni a plafone e a sospensione. Le differenti versioni, da appoggio o da incasso, soddisfano ogni esigenza di installazione. La completezza degli accessori rende LKM ideale nella progettazione illuminotecnica per flessibilità e versatilità. Tensione di rete 230/250V. Tensione di rete industriale 380/440V. Carico complessivo 16A.

EN Light Kit Main is a system of three-phase tracks with three circuits, available in 4 different lengths for installation on the ceiling or on the wall. The range, which also includes recessed tracks, is suitable for several installation needs. The complete range of accessories makes LKM extremely flexible and versatile in lighting design. Power supply 230/250V. Industrial power supply 380/440V. Total load 16A.

Tipologie di binari

Il binario trifase LKM è disponibile in tre versioni: a sezione tonda e quadra. La versione da incasso è dotata di due alette laterali che permettono l'appoggio su controsoffitti o pannellature.

Track version

The three-phase LKM track is available in 3 designs: round or square shaped. The recessed one is supplied with two side wings, to allow installation in false ceilings and panels.

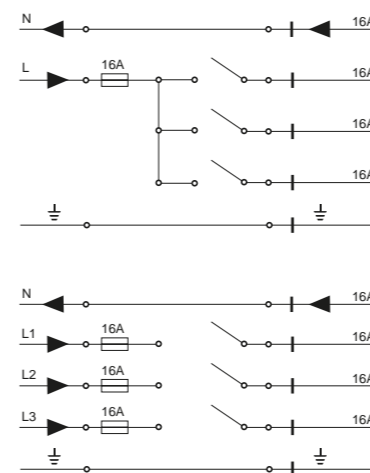

ITA SCHEMI ELETTRICI

Il collegamento a una rete elettrica monofase 230/250V consente un carico complessivo di 16A, che corrisponde a 3680/4000 Watt suddivisibile su tre circuiti. Il collegamento alla rete elettrica trifase 230/400V consente un carico complessivo di 16A, che corrisponde a 11040 Watt ripartibili su tre circuiti (3x3680 Watt).

EN WIRING DIAGRAMS

The connections to a single phase 230/250V mains allows a total load of 16A, corresponding to 3680/4000 Watt, which can be divided among 3 circuits. The connection to a three-phase 230/400V electricity mains allows a total load of 16A, corresponding to 11040 Watt, which can be divided among 3 circuits (3x3680 Watt).

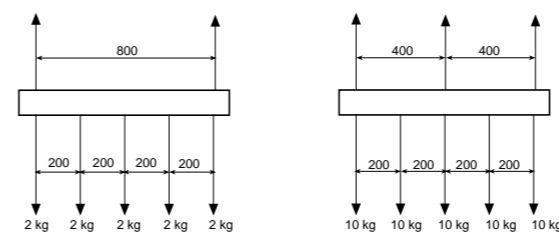

ITA CAPACITÀ DI CARICO

I binari trifase LKM possono sopportare un carico di 2 Kg ogni 200 mm con una distanza massima fra i punti di fissaggio di 800 mm. Nel caso di carico di 10 Kg ogni 200 mm, la distanza di fissaggio deve essere di 400 mm.

EN LOAD CAPACITY

LKM three-phase tracks have a load capacity of 2 Kg every 200 mm, with a maximum distance of 800 mm between the fixing points. For a 10 Kg load every 200 mm, a maximum fixing distance of 400 mm is recommended.

Continuità della messa a terra (vista in planimetria dall'alto)
Continuity of the earthing (top plan view)

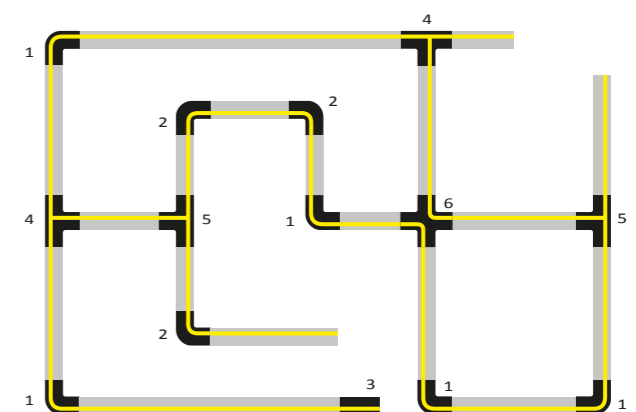

ITA CONTINUITÀ DELLA MESSA A TERRA

Per una corretta installazione di tutti gli accessori che concorrono alla formazione di un impianto di binari trifase, ha grande importanza la continuità della linea di messa a terra tra ogni elemento. Il posizionamento dei conduttori di terra, infatti, deve essere consequenziale tra componente e componente.

EN CONTINUITY OF THE EARTHING

For a correct installation of all the accessories in a three-phase track composition, the continuity of the earthing between each element has the highest importance. The earth conductors of each component must be positioned consistently.



Conduttore di terra con alimentazione sinistra L

Conduttore di terra con alimentazione destra R

Live-end with earth on the left L

Live-end with earth on the right R



MM

^{ITA} Mini Main è un sistema di binari elettrificati monofase di facile installazione, compatibile con alcuni proiettori della collezione Ivela. Alimentazione alla rete monofase 230-250V, carico complessivo di 16A corrispondente a 3680/4000W.

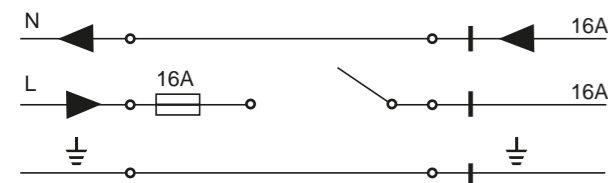

Schema elettrico

Wiring diagram

Il collegamento alla rete elettrica monofase 230/250V consente un carico complessivo di 16A che corrisponde a 3680/4000 Watt.

Connection to single-phase 230/250V mains allows a total load of 16A, corresponding to 3680/4000 Watt.

^{EN} Mini Main is a single-phase electrified track system, easy to install and compatible with some spotlights of the Ivela range. Connection to single phase 230-250V mains, total load of 16A corresponding to 3680/4000W.

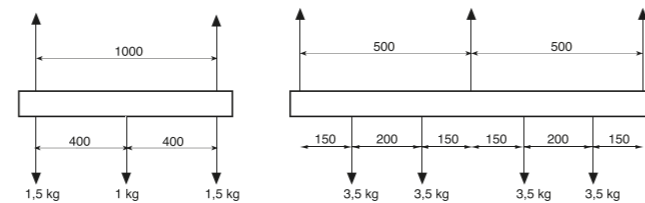

Capacità di carico

Il binario può sopportare un carico di 4 Kg ogni 1000 mm. Nel caso di carico di 7 Kg, la distanza di fissaggio deve essere di 500 mm.

Load capacity

The track has a load capacity of 4 Kg every 1000 mm. For a 7 Kg load a maximum fixing distance of 500 mm is recommended.



Products

Pages



48V_{DC} Quadro _ Square

160



48V_{DC} Incasso TL _ TL Recessed

161



DKM Quadro _ Square

162



DKM Incasso _ Recessed

163



LKM Tondo _ Round

164



LKM Quadro _ Square

165



LKM Incasso _ Recessed

166



MM

167

48Vdc
QUADRO/SQUARE



Codice Code	Lunghezza Length (mm)
Binari a bassa tensione Low voltage tracks	
6445-10	1000
6445-20	2000
6445-30	3000
48Vdc - 15A	

21 Bianco mat / Mat white 16 Nero / Black

CE IP20

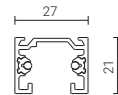

Binari elettrificati Electrified tracks

48Vdc
INCASSO TL / TL RECESSED

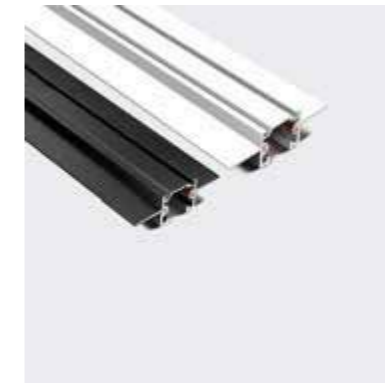

Codice Code	Lunghezza Length (mm)
Binari a bassa tensione Low voltage tracks	
6446-10	1000
6446-20	2000
6446-30	3000
48Vdc - 15A	

31 Bianco / White 30 Nero / Black

CE IP20

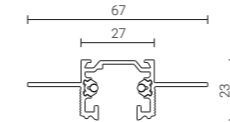

Accessori binario 48Vdc quadro / 48Vdc square track accessories

<p>6453-00 Giunto lineare Straight joint</p> <p>30 31 25 850°</p>	<p>6454-10 Giunto lineare senza contatti Mechanical joint without electrical contacts</p> <p>30 31 25 850°</p>	<p>6455-10 Giunto L interno / Inside L joint</p> <p>6455-11 Giunto L esterno / Outside L joint</p> <p>30 31 5 850°</p>	<p>6464-10 Giunto T destro / Right T joint</p> <p>6464-11 Giunto T sinistro / Left T joint</p> <p>30 31 4 850°</p>
<p>6456-00 Giunto flessibile Flexible joint</p> <p>30 31 2 850°</p>	<p>6458-06 (2000 mm) Kit sospensione con cavo acciaio, piattina e bloccacavo automatico Suspension kit with steel wire, plate and automatic locking device</p> <p>30 31 10 850°</p>	<p>6458-00 (2000 mm) Kit sospensione con cavo acciaio e piattina / Suspension kit with steel wire and plate</p> <p>30 31 10 850°</p>	<p>6459-20 Kit soffitto/parete a coppia Wall/ceiling pair</p> <p>30 31 10 850°</p>
<p>6463-00-00 Kit attacco soffitto Ceiling kit</p> <p>30 31 10 850°</p>	<p>6461-00 (1000 mm) Copertura binario Track cover</p> <p>30 31 10 850°</p>	<p>6460-00 Chiusura Dead end</p> <p>30 31 10 850°</p>	

Accessori binario 48Vdc incasso / 48Vdc recessed track accessories

<p>6453-00 Giunto lineare Straight joint</p> <p>30 31 25 850°</p>	<p>6454-10 Giunto lineare senza contatti Mechanical joint without electrical contacts</p> <p>30 31 25 850°</p>	<p>6484-10 Giunto L interno Inside L joint</p> <p>30 31 5 850°</p>	<p>6484-11 Giunto L esterno Outside L joint</p> <p>30 31 5 850°</p>
<p>6457-00-00 (120 mm) Piattina (obbligatoria per la congiunzione di più binari) / Plate (compulsory for the connection between tracks)</p> <p>120 1 850°</p>	<p>6461-00 (1000 mm) Copertura binario Track cover</p> <p>1000 30 31 10 850°</p>	<p>6483-00 Chiusura Dead end</p> <p>27 30 31 10 850°</p>	

Alimentatori binario 48Vdc quadro / 48Vdc square track live-ends

<p>6451-10 Alimentazione destra Right live-end</p> <p>30 31 10 850°</p>	<p>6451-11 Alimentazione sinistra Left live-end</p> <p>30 31 10 850°</p>	<p>6452-00 Alimentazione centrale Central connector</p> <p>85 30 31 5 850°</p>
--	---	---

Alimentatori binario 48Vdc incasso TL / 48Vdc TL recessed track transformers

<p>6480-10 Alimentazione destra Right live-end</p> <p>30 31 10 850°</p>	<p>6480-11 Alimentazione sinistra Left live-end</p> <p>30 31 10 850°</p>	<p>6481-00 Alimentazione centrale Central connection</p> <p>85 30 31 5 850°</p>
--	---	--

Trasformatori binario 48Vdc quadro / 48Vdc square track transformers

- 81-09000**
Trasformatore PWM 100W 230V/48V per uso remoto
100W 230V/48V PWM transformer for remote use
- 81-09001**
Trasformatore PWM 200W 230V/48V per uso remoto
200W 230V/48V PWM transformer for remote use
- 81-90122**
Trasformatore PWM 300W 230V/48V per uso remoto
300W 230V/48V PWM transformer for remote use
- 6465-03-31**
Trasformatore elettronico 150W 220-240V/48Vdc DALI per uso remoto / 150W 220-240V/48VDC DALI electronic transformer for remote use

Dispositivi di regolazioni per trasformatori binario 48Vdc quadro / Dimmers and controllers for 48Vdc square tracks transformers

- 81-90089**
Dimmer Casambi Bluetooth 48V 4 canali (per trasformatori cod. 81-09000, 81-09001, 81-90122)
Bluetooth Casambi dimmer 48V 4 channels (for transformers codes 81-09000, 81-09001, 81-90122)
- 81-90124**
Dimmer DALI (per trasformatori cod. 81-09000, 81-09001, 81-90122)
DALI dimmer (for transformers codes 81-09000, 81-09001, 81-90122)
- 81-90123**
Dimmer PWM (per trasformatori cod. 81-09000, 81-09001, 81-90122)
PWM dimmer (for transformers codes 81-09000, 81-09001, 81-90122)
- 81-90128**
Controller Bluetooth DALI (per trasformatore cod. 6465-03-31)
Bluetooth DALI controller (for transformer code 6465-03-31)

Trasformatori binario 48Vdc incasso TL / 48Vdc TL recessed track transformers

- 81-09000**
Trasformatore PWM 100W 230V/48V per uso remoto
100W 230V/48V PWM transformer for remote use
- 81-09001**
Trasformatore PWM 200W 230V/48V per uso remoto
200W 230V/48V PWM transformer for remote use
- 81-90122**
Trasformatore PWM 300W 230V/48V per uso remoto
300W 230V/48V PWM transformer for remote use
- 6465-03-31**
Trasformatore elettronico 150W 220-240V/48Vdc DALI per uso remoto / 150W 220-240V/48VDC DALI electronic transformer for remote use

Dispositivi di regolazioni per trasformatori binario 48Vdc incasso TL / Dimmers and controllers for 48Vdc TL recessed tracks transformers

- 81-90089**
Dimmer Casambi Bluetooth 48V 4 canali (per trasformatori cod. 81-09000, 81-09001, 81-90122)
Bluetooth Casambi dimmer 48V 4 channels (for transformers codes 81-09000, 81-09001, 81-90122)
- 81-90124**
Dimmer DALI (per trasformatori cod. 81-09000, 81-09001, 81-90122)
DALI dimmer (for transformers codes 81-09000, 81-09001, 81-90122)
- 81-90123**
Dimmer PWM (per trasformatori cod. 81-09000, 81-09001, 81-90122)
PWM dimmer (for transformers codes 81-09000, 81-09001, 81-90122)
- 81-90128**
Controller Bluetooth DALI (per trasformatore cod. 6465-03-31)
Bluetooth DALI controller (for transformer code 6465-03-31)

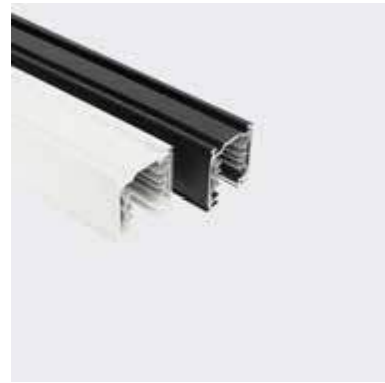

Codice Code	Lunghezza Length (mm)
Binario monofase DKM dimmerabile quadro DKM single-phase square dimmable tracks	
7520-10	1000
7520-20	2000
7520-30	3000
7520-40	4000
230/250V - 16A	

31 Bianco White 30 Nero Black

CE IP20

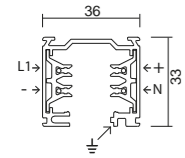

Codice Code	Lunghezza Length (mm)
Binario monofase DKM dimmerabile da incasso DKM single-phase recessed dimmable tracks	
7521-20	2000
7521-30	3000
230/250V - 16A	

31 Bianco White 30 Nero Black

CE IP20

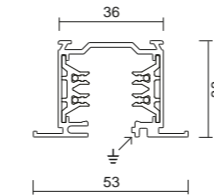

Adattatore e alimentatori / Adapter and live-ends

<p>7559-00 (portata / load 10kg) Adattatore elettromeccanico DALI 6A / DALI electro/mechanical adapter 6A</p> <p>30 31 10</p>	<p>7651-10-W Alimentazione destra / Right live-end</p> <p>30 31 10</p>	<p>7651-11-W Alimentazione sinistra / Left live-end</p> <p>30 31 10</p>	<p>7661-10-W Alimentazione centrale e giunto lineare / Central connector and straight joint</p> <p>30 31 2</p>
--	---	--	---

Accessori DKM / DKM accessories

<p>7655-10-W Giunto L interno / Inside L joint</p> <p>30 31 4</p>	<p>7656-10-W Giunto T destro / Right T joint</p> <p>30 31 2</p>	<p>7657-10-W Giunto X / X joint</p> <p>30 31 2</p>	<p>7658-10-W Giunto flessibile / Flexible joint</p> <p>30 31 2</p>
<p>7660-00-W Giunto mobile / Mobile joint</p> <p>30 31 4</p>	<p>7604Q-10-W Giunto lineare elettrificato con contatti e blocco / Electrical joint with stop</p> <p>30 31 6</p>	<p>7654-10-W Giunto lineare con blocco senza contatti (solo meccanico) / Mechanical straight joint with stop without electrical contacts</p> <p>30 31 6</p>	<p>7625-00 Adattatore meccanico / Mechanical adapter</p> <p>30 31 10</p>
<p>7618-00 (2000 mm) Adattatore meccanico con bloccacavo e cavo acciaio / Mechanical adapter with automatic locking and steel wire</p> <p>30 31 10</p>	<p>7606-05 (2000 mm) Kit sospensione con cavo acciaio e piastrina 120 mm / Suspension kit with steel wire and 120 mm plate</p> <p>30 31 10</p>	<p>7606-06 (2000 mm) Kit sospensione con cavo acciaio, piastrina 60 mm e bloccacavo automatico / Suspension kit with steel wire, 60 mm plate and automatic locking device</p> <p>30 31 10</p>	<p>7606-00 (2000 mm) Kit sospensione con cavo acciaio e piastrina 60 mm / Suspension kit with steel wire and 60 mm plate</p> <p>30 31 10</p>
<p>7626-00-00 (1000 mm) Kit sospensione con tige e rosone traslucido / Suspension kit with pipe and translucent ceiling base</p> <p>30 31 4</p>	<p>7659-00-W Terminale di chiusura / Dead end</p> <p>30 31 10</p>	<p>7606-04-00 (120 mm) Piastrina / Plate</p> <p>30 31 50</p>	<p>7609-00-00 Raccordo per adattatore elettromeccanico M10x1 / Nut for electro/mechanical adapter M10x1</p> <p>30 31 10</p>
<p>7607-00-00 Kit attacco soffitto / Ceiling kit</p> <p>30 31 10</p>	<p>7624-00 (1000 mm) Copertura binario / Track cover</p> <p>30 31 10</p>		

Adattatore e alimentatori / Adapter and live-ends

<p>7559-00 (portata / load 10kg) Adattatore elettromeccanico DALI 6A / DALI electro/mechanical adapter 6A</p> <p>30 31 10</p>	<p>7665-10-W Alimentazione destra / Right live-end</p> <p>30 31 8</p>	<p>7665-11-W Alimentazione sinistra / Left live-end</p> <p>30 31 8</p>	<p>7666-10-W Alimentazione centrale e giunto lineare / Central connector and straight joint</p> <p>30 31 2</p>
--	--	---	---

Accessori DKM incasso / Recessed DKM accessories

<p>7604-10-W Giunto lineare elettrificato con contatti / Electrical straight joint</p> <p>30 31 6</p>	<p>7654-10-W Giunto lineare con blocco senza contatti (solo meccanico) / Mechanical straight joint with stop without electrical contacts</p> <p>30 31 6</p>	<p>7625-00 Adattatore meccanico / Mechanical adapter</p> <p>30 31 10</p>	<p>7618-00 (2000 mm) Adattatore meccanico con bloccacavo e cavo acciaio / Mechanical adapter with automatic locking and steel wire</p> <p>30 31 10</p>
<p>7664-00-48 Sospensione per controsoffitto / Suspension for false ceiling</p> <p>30 31 10</p>	<p>7659I-00-W Terminale di chiusura / Dead end</p> <p>30 31 10</p>	<p>7609-00-00 Raccordo per adattatore elettromeccanico M10x1 / Nut for electro/mechanical adapter M10x1</p> <p>30 31 10</p>	<p>7607-00-00 Kit attacco soffitto / Ceiling kit</p> <p>30 31 10</p>
<p>7624-00 (1000 mm) Copertura binario / Track cover</p> <p>30 31 10</p>			



Codice Code	Lunghezza Length (mm)
Binario LKM trifase tondo LKM 3-phase round track	
7501-10	1000
7501-20	2000
7501-30	3000
230/440V-16A	

31 Bianco White 30 Nero Black

CE IP20

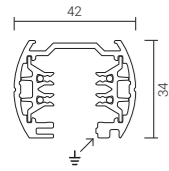

Codice Code	Lunghezza Length (mm)
Binario LKM trifase quadrato LKM 3-phase square track	
7511-10	1000
7511-20	2000
7511-30	3000
7511-40	4000
230/440V-16A	

31 Bianco White 30 Nero Black 42 Anodizzato naturale Satin silver

CE IP20

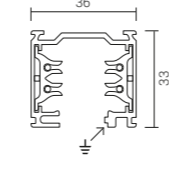

Adattatore e alimentatori / Adapter and live-ends

<p>7600-00 (portata / load 10kg) Adattatore elettromeccanico 6A Electro/mechanical adapter 6A</p> <p>30 31 8 850°</p>	<p>7558-00 (portata / load 5kg) Adattatore elettromeccanico 6A Electro/mechanical adapter 6A</p> <p>30 31 10 850°</p>	<p>7557-00 (200-700mA 8,8-31W, load 5kg) Adattatore elettromeccanico con driver elettronico integrato 220/240V Electro/mechanical adapter with integrated electronic driver 220/240V</p> <p>30 31 1 850°</p>	<p>7602-10-W Alimentazione destra Right live-end</p> <p>30 31 10 850°</p>
<p>7602-11-W Alimentazione sinistra Left live-end</p> <p>30 31 10 850°</p>	<p>7603-10-W Alimentazione centrale e giunto lineare / Central connector and straight joint</p> <p>30 31 2 850°</p>		

Accessori LKM tondo / Round LKM accessories

<p>7605-10-W Giunto L interno Inside L joint</p> <p>30 31 4 850°</p>	<p>7605-11-W Giunto L esterno Outside L joint</p> <p>30 31 4 850°</p>	<p>7621-10-W Giunto T destro Right T joint</p> <p>30 31 2 850°</p>	<p>7621-11-W Giunto T sinistro Left T joint</p> <p>30 31 2 850°</p>
<p>7622-10-W Giunto X X joint</p> <p>30 31 2 850°</p>	<p>7610-10-W Giunto flessibile Flexible joint</p> <p>30 31 2 850°</p>	<p>7604T-10-W Giunto lineare elettrificato con contatti e con blocco Electrical straight joint with stop</p> <p>30 31 6 850°</p>	<p>7625-00 Adattatore meccanico Mechanical adapter</p> <p>30 31 10 850°</p>
<p>7618-00 (2000 mm) Adattatore meccanico con bloccacavo e cavo acciaio Mechanical adapter with automatic locking and steel wire</p> <p>30 31 10 850°</p>	<p>7606-05 (2000 mm) Kit sospensione con cavo acciaio e piastrina 120 mm / Suspension kit with steel wire and 120 mm plate</p> <p>30 31 10 850°</p>	<p>7606-06 (2000 mm) Kit sospensione con cavo acciaio, piastrina 60 mm e bloccacavo automatico Suspension kit with steel wire, 60 mm plate and automatic locking device</p> <p>30 31 10 850°</p>	<p>7606-00 (2000 mm) Kit sospensione con cavo acciaio e piastrina 60 mm / Suspension kit with steel wire and 60 mm plate</p> <p>30 31 10 850°</p>
<p>7626-00-00 (1000 mm) Kit sospensione con tige e rosone traslucido / Suspension kit with pipe and translucent ceiling base</p> <p>4 850°</p>	<p>7623-00-W Terminale di chiusura Dead end</p> <p>30 31 10 850°</p>	<p>7606-04-00 (120 mm) Piastrina Plate</p> <p>50</p>	<p>7609-00-00 Raccordo per adattatore elettromeccanico M10x1 / Nut for electro/mechanical adapter M10x1</p> <p>10 850°</p>
<p>7607-00-00 Kit attacco soffitto Ceiling kit</p> <p>10 850°</p>	<p>7624-00 (1000 mm) Copertura binario Track cover</p> <p>30 31 10 850°</p>		

Adattatore e alimentatori / Adapter and live-ends

<p>7600-00 (portata / load 10kg) Adattatore elettromeccanico 6A Electro/mechanical adapter 6A</p> <p>30 31 20 8 850°</p>	<p>7558-00 (portata / load 5kg) Adattatore elettromeccanico 6A Electro/mechanical adapter 6A</p> <p>30 31 20 10 850°</p>	<p>7557-00 (200-700mA 8,8-31W, load 5kg) Adattatore elettromeccanico con driver elettronico integrato 220/240V Electro/mechanical adapter with integrated electronic driver 220/240V</p> <p>30 31 20 1 850°</p>	<p>7652-10-W Alimentazione destra Right live-end</p> <p>30 31 20 10 850°</p>
<p>7652-11-W Alimentazione sinistra Left live-end</p> <p>30 31 20 10 850°</p>	<p>7653-10-W Alimentazione centrale e giunto lineare / Central connector and straight joint</p> <p>30 31 20 2 850°</p>		

Accessori LKM quadro / Square LKM accessories

<p>7655-10-W Giunto L interno / Inside L joint</p> <p>30 31 20 4 850°</p>	<p>7656-10-W Giunto T destro / Right T joint</p> <p>30 31 20 2 850°</p>	<p>7657-10-W Giunto X X joint</p> <p>30 31 20 2 850°</p>	<p>7658-10-W Giunto flessibile Flexible joint</p> <p>30 31 20 2 850°</p>
<p>7655-11-W Giunto L esterno / Outside L joint</p> <p>30 31 20 4 850°</p>	<p>7656-11-W Giunto T sinistro / Left T joint</p> <p>30 31 20 2 850°</p>	<p>7654-10-W Giunto lineare con blocco senza contatti (solo meccanico) / Mechanical straight joint with stop without electrical contacts</p> <p>30 31 6 850°</p>	<p>7625-00 Adattatore meccanico Mechanical adapter</p> <p>30 31 50 10 850°</p>
<p>7660-00-W Giunto mobile Mobile joint</p> <p>30 31 20 4 850°</p>	<p>7604Q-10-W Giunto lineare elettrificato con contatti e blocco / Electrical straight joint with stop</p> <p>30 31 6 850°</p>	<p>7606-10-W (2000 mm) Kit sospensione con cavo acciaio e piastrina 120 mm / Suspension kit with steel wire and 120 mm plate</p> <p>30 31 10 850°</p>	<p>7606-06 (2000 mm) Kit sospensione con cavo acciaio, piastrina 60 mm e bloccacavo automatico Suspension kit with steel wire, 60 mm plate and automatic locking device</p> <p>30 31 10 850°</p>
<p>7618-00 (2000 mm) Adattatore meccanico con bloccacavo e cavo acciaio Mechanical adapter with pipe and translucent ceiling base</p> <p>30 31 10 850°</p>	<p>7606-05 (2000 mm) Kit sospensione con cavo acciaio e piastrina 120 mm / Suspension kit with steel wire and 120 mm plate</p> <p>30 31 10 850°</p>	<p>7606-06 (2000 mm) Kit sospensione con cavo acciaio, piastrina 60 mm e bloccacavo automatico Suspension kit with steel wire, 60 mm plate and automatic locking device</p> <p>30 31 10 850°</p>	<p>7606-00 (2000 mm) Kit sospensione con cavo acciaio e piastrina 60 mm / Suspension kit with steel wire and 60 mm plate</p> <p>30 31 10 850°</p>
<p>7626-00-00 (1000 mm) Kit sospensione con tige e rosone traslucido / Suspension kit with pipe and translucent ceiling base</p> <p>4 850°</p>	<p>7659-00-W Terminale di chiusura Dead end</p> <p>30 31 20 10 850°</p>	<p>7606-04-00 (120 mm) Piastrina Plate</p> <p>50</p>	<p>7609-00-00 Raccordo per adattatore elettromeccanico M10x1 / Nut for electro/mechanical adapter M10x1</p> <p>10 850°</p>
<p>7607-00-00 Kit attacco soffitto Ceiling kit</p> <p>10 850°</p>	<p>7624-00 (1000 mm) Copertura binario Track cover</p> <p>30 31 10 850°</p>		



Codice Code	Lunghezza Length (mm)
Binario trifase LKM da incasso LKM 3-phase recessed track	
7512-10	1000
7512-20	2000
7512-30	3000
7512-40	4000
230/440V-16A	

31 Bianco White 30 Nero Black

CE IP20

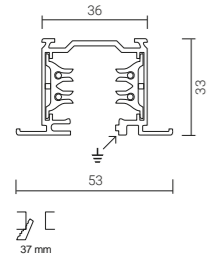





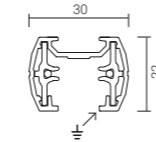

Codice Code	Lunghezza Length (mm)
Binario monofase MM MM single-phase track	
7701-10	1000
7701-20	2000
7701-30	3000
230/250V-16A	

31 Bianco White 30 Nero Black

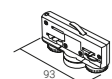



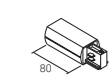





CE IP20



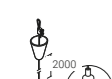







Adattatore e alimentatori / Adapter and live-ends

 <p>7600-00 (portata / load 10kg) Adattatore elettromeccanico 6A Electro/mechanical adapter 6A</p> <p>30 31 8 850°</p>	 <p>7558-00 (portata / load 5kg) Adattatore elettromeccanico 6A Electro/mechanical adapter 6A</p> <p>30 31 10 850°</p>	 <p>7557-00 (200-700mA 8,8-31W, load 5kg) Adattatore elettromeccanico con driver elettronico integrato 220/240V Electro/mechanical adapter with integrated electronic driver 220/240V</p> <p>30 31 1 850°</p>	 <p>7662-10-W Alimentazione destra Right live-end</p> <p>30 31 10 850°</p>
 <p>7662-11-W Alimentazione sinistra Left live-end</p> <p>30 31 10 850°</p>	 <p>7663-10-W Alimentazione centrale e giunto lineare / Central connector and straight joint</p> <p>30 31 2 850°</p>		

Accessori LKM incasso / Recessed LKM accessories

 <p>7604-10-W Giunto lineare elettrificato con contatti / Electrical straight joint</p> <p>30 31 6 850°</p>	 <p>7654-10-W Giunto lineare con blocco senza contatti (solo meccanico) Mechanical straight joint with stop without electrical contacts</p> <p>30 31 6 850°</p>	 <p>7625-00 Adattatore meccanico Mechanical adapter</p> <p>30 31 10 850°</p>	 <p>7618-00 (2000 mm) Adattatore meccanico con bloccacavo e cavo acciaio Mechanical adapter with automatic locking and steel wire</p> <p>30 31 10 850°</p>
 <p>7606-06 (2000 mm) Kit sospensione con cavo acciaio, piastrina 60 mm e bloccacavo automatico Suspension kit with steel wire, 60 mm plate and automatic locking device</p> <p>30 31 10 850°</p>	 <p>7606-00 (2000 mm) Kit sospensione con cavo acciaio e piastrina 60 mm / Suspension kit with steel wire and 60 mm plate</p> <p>30 31 10 850°</p>	 <p>7664-00-48 Sospensione per controsoffitto Suspension for false ceiling</p> <p>30 31 10 850°</p>	 <p>7659-00-W Terminale di chiusura Dead end</p> <p>30 31 10 850°</p>
 <p>7609-00-00 Raccordo per adattatore elettromeccanico M10x1 / Nut for electro/mechanical adapter M10x1</p> <p>30 31 10 850°</p>	 <p>7607-00-00 Kit attacco soffitto Ceiling kit</p> <p>30 31 10 850°</p>	 <p>7624-00 (1000 mm) Copertura binario Track cover</p> <p>30 31 10 850°</p>	

Accessori MM / MM accessories

 <p>7802-00-W Alimentazione Live-end</p> <p>30 31 4 850°</p>	 <p>7803-00-W Alimentazione centrale Central connector</p> <p>30 31 6 850°</p>	 <p>7800-00 (portata / load 5kg) Adattatore elettromeccanico 6A (M10x1) / Electro/mechanical adapter 6A (M10x1)</p> <p>30 31 1 850°</p>	 <p>7805-00-W Giunto L L joint</p> <p>30 31 2 850°</p>
 <p>7810-00-W Giunto flessibile Flexible joint</p> <p>30 31 8 850°</p>	 <p>7804-00-W Giunto lineare elettrificato con contatti / Electrical straight joint</p> <p>30 31 10 850°</p>	 <p>7806-00 (2000 mm) Kit sospensione con cavo acciaio e piastrina 56 mm / Suspension kit with steel wire and 56 mm plate</p> <p>30 31 10 850°</p>	 <p>7807-02-W Kit soffitto/parete a coppia Wall/ceiling pair</p> <p>30 31 50 850°</p>
 <p>7823-00-W Terminale di chiusura Dead end</p> <p>30 31 10 850°</p>			

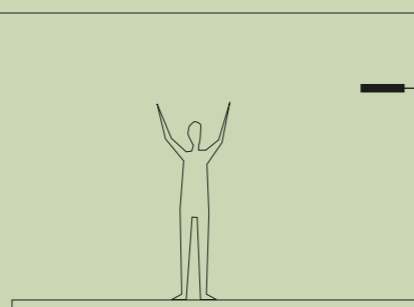
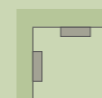

Il design al centro della scena

The design takes center stage

^{ITA} I prodotti della gamma di luci da parete e plafone rappresentano l'ibrido perfetto tra vintage e modernità. Tutta la serie è caratterizzata da un profilo particolarmente sottile e da forme geometriche essenziali quali il cerchio e il quadrato, che le consentono di essere collocata in spazi anche con altezze ridotte, a soffitto o a parete, in ambiti sia residenziali che pubblici. Prodotti versatili che fanno della semplicità di installazione un punto di forza fondamentale.

^{EN} The products in the range of wall and ceiling lights represent the perfect hybrid between vintage and modernity. The whole series features a very shallow profile and minimal geometric shapes such as the circle and the square, which allow it to be placed in spaces even with reduced heights, on the ceiling or wall, in both residential and public settings. Versatile products that make installation simplicity a fundamental strength.





AP Line

^{ITA} Le luci da parete e plafone di questa gamma esprimono al meglio il potenziale pensato in fase di sviluppo. Grazie alle differenti caratteristiche possono soddisfare le più varie esigenze illuminotecniche, da luce diffusa verso l'alto a luce d'accento verso il basso. Nessun dettaglio è lasciato al caso, l'unico obiettivo è la valorizzazione degli ambienti.

AP Line e la serie PF sono modelli di design depositato.
Design: Enrico Davide Bona e Elisa Nobile.

^{EN} The wall and ceiling lights best express the potential conceived in the development phase. Thanks to the different features, they can satisfy the most various lighting requirements, from diffused up-light to accent light. No detail is left to chance: the only purpose is the magnification of the spaces.

AP Line e the PF range are registered design models.
Design: Enrico Davide Bona and Elisa Nobile.



PF22



Wall Lights



Ceiling Lights

INDEX

AP LINE



Codice Code	LED Lumen	Product Lumen	Watt	Colour T (K)	CRI	Fascio Beam
3748-01	2800	2128	30	3000	85	110°

220/240V - 50/60Hz

21 Bianco mat
Mat white

CE IP40

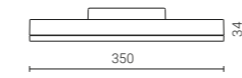
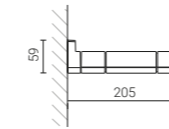

1,8 Kg

Products

Pages



AP Line

173



PF 15

174



PF 22

174



PF 19

175



PF 30

175

PF 15



Codice Code	LED Lumen	Product Lumen	Watt	Colour T (K)	CRI	Fascio Beam
3825-01	1700	1088	12	3000	85	110°

220/240V - 50/60Hz

21 Bianco mat
Mat white

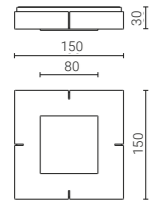

0,7 Kg

PF 22



Codice Code	LED Lumen	Product Lumen	Watt	Colour T (K)	CRI	Fascio Beam
3830-01	2400	1721	18	3000	85	110°

220/240V - 50/60Hz

21 Bianco mat
Mat white

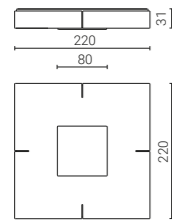

1,2 Kg

plafone/ ceiling lights - exterior

PF 19



Codice Code	LED Lumen	Product Lumen	Watt	Colour T (K)	CRI	Fascio Beam
3881-01	1800	1320	12	3000	85	110°

Regolabile sulla fase / Dimmable on the mains
230/240V - 50/60Hz

21 Bianco mat
Mat white

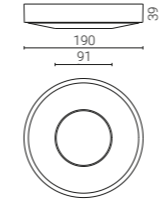

0,7 Kg

PF 30



Codice Code	LED Lumen	Product Lumen	Watt	Colour T (K)	CRI	Fascio Beam
3888-02	3400	2479	26	3000	85	100°

230/240V - 50/60Hz

21 Bianco mat
Mat white

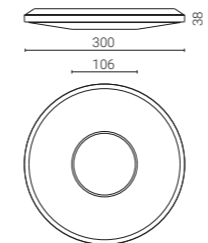

1,5 Kg

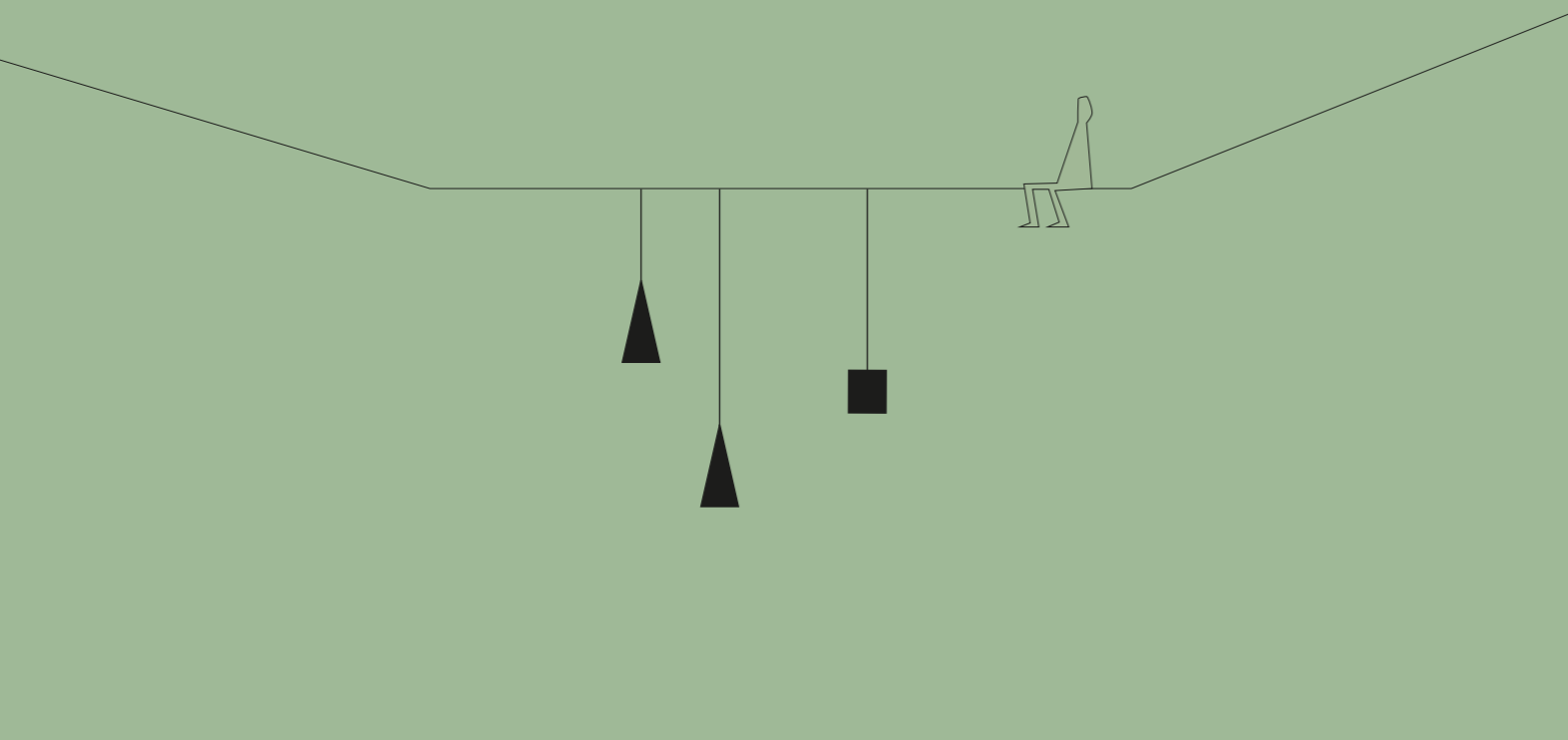
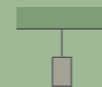

Luci che danzano lievi sulla scena

Lights that dance lightly on the stage

^{ITA} Sottili fili in tessuto sospendono in aria i corpi luminosi. Di grande effetto scenografico, i punti luce sono forme leggere e lineari da cui fuoriesce la giusta luce per creare accenti e atmosfere. Ideali in abbinamento ad altri apparecchi, per soluzioni architettoniche formali e funzionali allo stesso tempo.

^{EN} Thin fabric wires suspend the luminous bodies in the air. The pendant design is made to be minimalistic, linear shapes for a great visual effect, providing both accent and atmosphere lighting. Ideal in combination with other fittings, to meet both formal and functional demands.



Miniperfetto-S



JRK Design Showroom – Geneve
Miniperfetto-S custom version

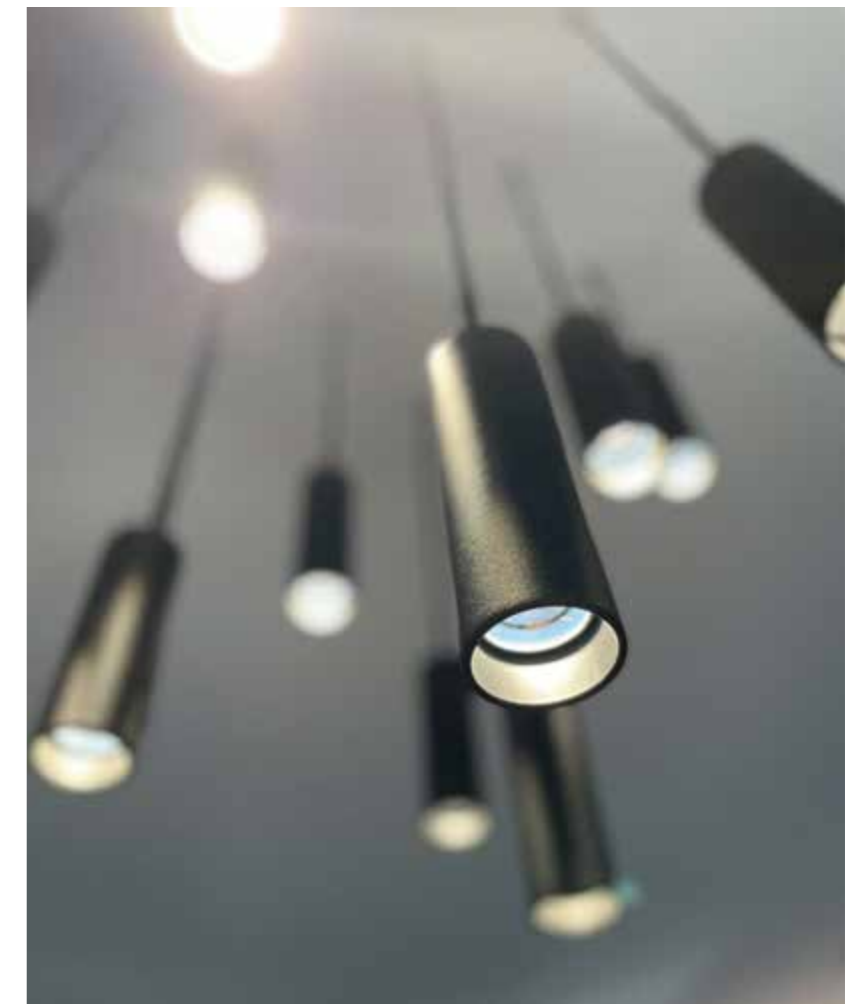

^{ITA} Miniperfetto-S è l'elegante versione a sospensione della gamma di proiettori Miniperfetto. Consente soluzioni illuminotecniche su misura, ideali per ogni esigenza progettuale. Le ottiche arretrate e lo snoot di serie riducono al minimo l'abbagliamento. Il suo design, dalle linee compatte e dalla sottile testa cilindrica, si inserisce facilmente in numerosi contesti, dal retail, all'hospitality, al residenziale.

^{EN} Miniperfetto-S is the elegant suspended version of the Miniperfetto spotlight range. It allows customized lighting solutions, ideal for every design requirement. The retracted optics and the standard snoot reduce glare to a minimum. Its design, with solid lines and a thin cylindrical head, fits easily into numerous contexts, from retail to hospitality to residential.



^{ITA} Nanoperfetto-S è una sospensione ideale in abbinamento ad altri apparecchi dal medesimo design. Miniaturizzato e quasi impercettibile è un prodotto integrabile in ogni contesto ambientale. Progettati con sorgenti LED COB ad alta efficienza luminosa, sono ideali sia come singolo punto luce, sia in composizione multipla. Le ottiche arretrate e lo snoot di serie consentono un elevato comfort visivo. Nanoperfetto-S si installa nel controsoffitto grazie all'apposito rosone.

^{EN} Nanoperfetto-S is a tiny suspension ideal when combined with other luminaries with a similar design. It can be integrated into any space thanks to its miniaturized and almost imperceptible shape. Designed with high luminous efficiency COB LED sources, it is ideal as a single light point and as multiple compositions. The rearward optics and the standard snoot allow a high visual comfort. Nanoperfetto-S has a canopy for installation in false ceilings.



Nanoperfetto-S + Linea 48Voc



Iconica versione custom / Iconica custom version

^{ITA} Iconica è caratterizzata da un design puro ed evocativo: la forma conica essenziale ed elegante del corpo è segnata da quattro scanalature in corrispondenza dell'innesto del cavo elettrico. Un segno che diventa così elemento di giunzione tra il volume del cono e il cavo in tessuto nero. Il rosone a soffitto è stato progettato come un cono rovesciato, in simmetria con l'apparecchio.

Iconica è modello di design depositato.
Design: Enrico Davide Bona e Elisa Nobile.

^{EN} Iconica features a clean and evocative design. The conical shape of the body, essential and elegant, is lined by four grooves, marking the connection between the volume of the cone and the cable in black fabric. The ceiling canopy has been designed as an inverted cone in symmetry with the luminaire.

Iconica is a registered design model.
Design: Enrico Davide Bona and Elisa Nobile.

Sospensioni

Pendants



Products

Pages



Nanoperfetto-S

184



Miniperfetto-S

185



Perfetto Compact-S

185



Iconica

186



Floot

188



Zeppel 400

189



Codice Code	LED Lumen	Product Lumen	Watt	mA	Colour T (K)	CRI	Fascio Beam
Con rosone per installazione a incasso in controsoffitto With canopy for recessed installation in a false ceiling							
752-219CVN	340	222	3,5	350	2700	90	54°
	470	307	4,5	500	2700	90	54°
	620	405	6,5	700	2700	90	54°
752-219BVN	355	248	3,5	350	3000	90	54°
	490	343	4,5	500	3000	90	54°
	650	425	6,5	700	3000	90	54°

Driver da ordinare separatamente / Driver should be ordered separately

- 81-02408** Output 350mA
- 81-04029** Output 500mA
Regolabile sul taglio di fase / Dimmable on the mains
- 81-04027** Output 700mA
Regolabile sul taglio di fase / Dimmable on the mains
- 81-04028** Output 700mA*
Dimmerabile DALI / DALI dimmable

*Per una corretta installazione, considerare una profondità di incasso a soffitto di 200 mm
For a correct installation, please consider a ceiling recessed depth of 200 mm

CE IP20

21 Bianco mat / Mat white 16 Nero / Black

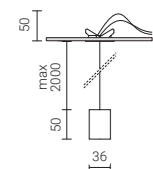

h 50 mm Ø 42 mm 0,4 Kg



Codice Code	LED Lumen	Product Lumen	Watt	Colour T (K)	CRI	Fascio Beam
748-219C	1100	914	9	2700	90	30°
748-219CV	1100	914	9	2700	90	45°
748-219	1170	972	9	3000	90	30°
748-219BV	1170	972	9	3000	90	45°
748-119	1469	1221	12	3000	90	30°
748-119BV	1469	1221	12	3000	90	45°

9W: Regolabile sulla fase / Dimmable on the mains
220/240V - 50/60Hz

CE IP20

21 Bianco mat / Mat white 16 Nero / Black

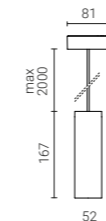

0,5 Kg

PERFETTO COMPACT - S



Codice Code	LED Lumen	Product Lumen	Watt	Colour T (K)	CRI	Fascio Beam
751-211	3125	2278	26	3000	85	29°
751-211BW	3125	2278	26	3000	85	42°

220/240V - 50/60Hz

CE IP20

21 Bianco mat / Mat white 16 Nero / Black

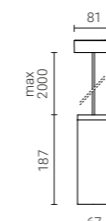

1,0 Kg

Accessori ottici intercambiabili solo per Miniperfetto - S
Replaceable optical accessories only for Miniperfetto - S

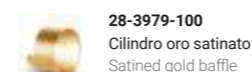

28-3979-100
Cilindro oro satinato
Satinated gold baffle



28-4536-30
Frangiluce alveolare
Honeycomb

Accessori ottici intercambiabili solo per Perfetto Compact - S
Replaceable optical accessories only for Perfetto Compact - S



28-9004-30
Cilindro antiabbagliamento
Snoot



28-4080-30
Frangiluce alveolare (da utilizzare insieme a snoot cod. 28-9004-30)
Honeycomb (to be used with snoot code 28-9004-30)



28-3905-47
Schermo di chiusura in termoplastico trasparente
Closing screen in clear thermoplastic material

Accessori ottici intercambiabili / Replaceable optical accessories



28-4175-100
Cilindro oro satinato
Satinated gold baffle



28-4200-30
Frangiluce alveolare
Honeycomb



- 21 **Bianco mat**
Mat white
- 16 **Nero**
Black
- 88 **Rame spazzolato**
Brushed copper

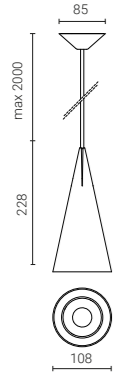

1.3 Kg

Codice Code	LED Lumen	Product Lumen	Watt	Colour T (K)	CRI	Fascio Beam
-------------	-----------	---------------	------	--------------	-----	-------------

Con driver integrato 230V / With 230V integrated driver

3920-02C	1494	1330	12	2700	90	55°
3920-02	1555	1384	12	3000	90	55°

Regolabile sulla fase / Dimmable on the mains

220/240V - 50/60Hz



Codice Code	LED Lumen	Product Lumen	Watt	mA	Colour T (K)	CRI	Fascio Beam
-------------	-----------	---------------	------	----	--------------	-----	-------------

Driver da ordinare separatamente / LED drivers should be ordered separately

3922-02CN	2759	2454	26	700	2700	90	55°
3922-02BN	2872	2556	26	700	3000	90	55°

Driver per uso remoto da ordinare separatamente
LED drivers for remote use should be ordered separately

- 81-04012** Output 700mA
- 81-04044** Output 700mA
Regolabile sul taglio di fase / Dimmable on the mains
- 81-02413** Output 700mA
Dimmerabile DALI / DALI dimmable



Iconica

Accessori ottici intercambiabili / Replaceable optical accessories



28-3140-51
Ottica professionale S (diffusore incluso)
Professional optic device S
(included diffuser)
Fascio / Beam: 12°



28-3142-51
Ottica professionale M
Professional optic device M
Fascio / Beam: 30°



28-3141-31
Ottica professionale XW
Professional optic device XW
Fascio / Beam: 70°



28-3957-30
Cilindro antiabbagliamento
Snoot



28-3959-30
Frangiluce alveolare (da utilizzare
insieme a snoot cod. 28-3957-30)
Honeycomb (to be used with snoot
code 28-3957-30)



Codice Code	LED Lumen	Product Lumen	Watt	Colour T (K)	CRI	Fascio Beam
Diffusore in policarbonato traslucido e vano componenti in pressofusione di alluminio Diffuser in translucent polycarbonate and gear box in die-cast aluminium						
3916-01	4800	4258	33	3000	85	70°
3915-01	6800	5873	51	3000	85	70°

220/240V - 50/60Hz

06 Bianco / Traslucido
White / Translucent

CE IP20 IK06

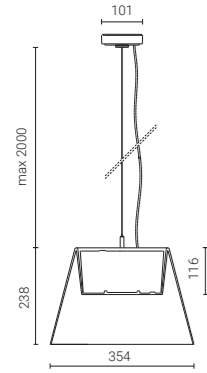

4,1 Kg

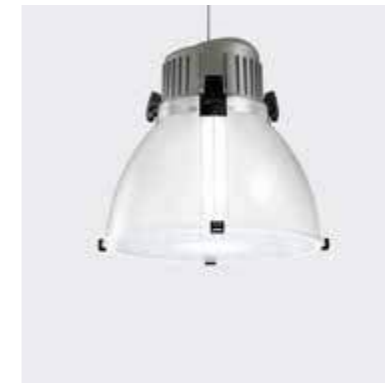

Codice Code	Attacco Base
Riflettore in policarbonato traslucido o metallizzato, schermo di protezione in vetro temprato 4mm / Polycarbonate reflector in translucent or metallized finish, safety screen in 4mm tempered glass	
439-011	E27

CE IP44 IK08

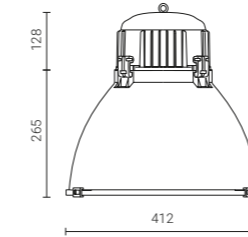

3,2 Kg

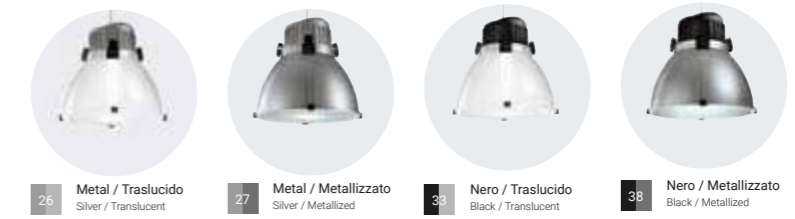

Accessori ottici intercambiabili / Replaceable optical accessories



28-3140-51
Ottica professionale S (diffusore incluso)
Professional optic device S
(included diffuser)
Fascio / Beam: 17° (33W)
Fascio / Beam: 25° (51W)



28-3142-51
Ottica professionale M
Professional optic device M
Fascio / Beam: 30° (33W)
Fascio / Beam: 40° (51W)



28-3138-51
Ottica professionale W
Professional optic device W
Fascio / Beam: 55° (33W)
Fascio / Beam: 60° (51W)



28-3957-30
Cilindro antiabbagliamento
Snoot



28-3959-30
Frangiluce alveolare (da utilizzare insieme a snoot cod. 28-3957-30)
Honeycomb (to be used with snoot code 28-3957-30)

Adattatori per binari trifase LKM / Adapters for LKM three-phase tracks



7558-00 (portata / load 5kg)
Adattatore elettromeccanico 6A
Electro/mechanical adapter 6A



7618-00
Adattatore meccanico con bloccacavo / Mechanical adapter with automatic locking device

31

31

Accessori / Accessories



160976 (2000mm)
Kit di sospensione con rosone traslucido, cavo acciaio e cavo alimentazione 2 x 0,75 mm²
Suspension kit with translucent canopy, steel wire, supply cable 2 x 0,75 mm²

Adattatori per binari trifase LKM / Adapters for LKM three-phase tracks

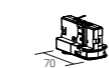

7558-00 (portata / load 5kg)
Adattatore elettromeccanico 6A
Electro/mechanical adapter 6A



7618-00
Adattatore meccanico con bloccacavo / Mechanical adapter with automatic locking device

30 31

30 31



Come riflessi sottili, ad esaltare la scena

As subtle reflections, they enhance the scene

^{ITA} Le stripled e i profili della gamma Aria sono prodotti in grado di esaltare l'atmosfera di ogni contesto nel quale vengono inseriti. Seppur nascosti e quasi non tangibili, sono in realtà sempre al centro della scena: con lievi bagliori o luce diffusa rendono protagonisti anche i dettagli invisibili.

^{EN} The LED strips and profiles of the Aria range are tools that can enhance the atmosphere of any context where they are. Although hidden and almost intangible, they are always at the center of the scene: with slight glows or diffused light, even the invisible details become protagonists.

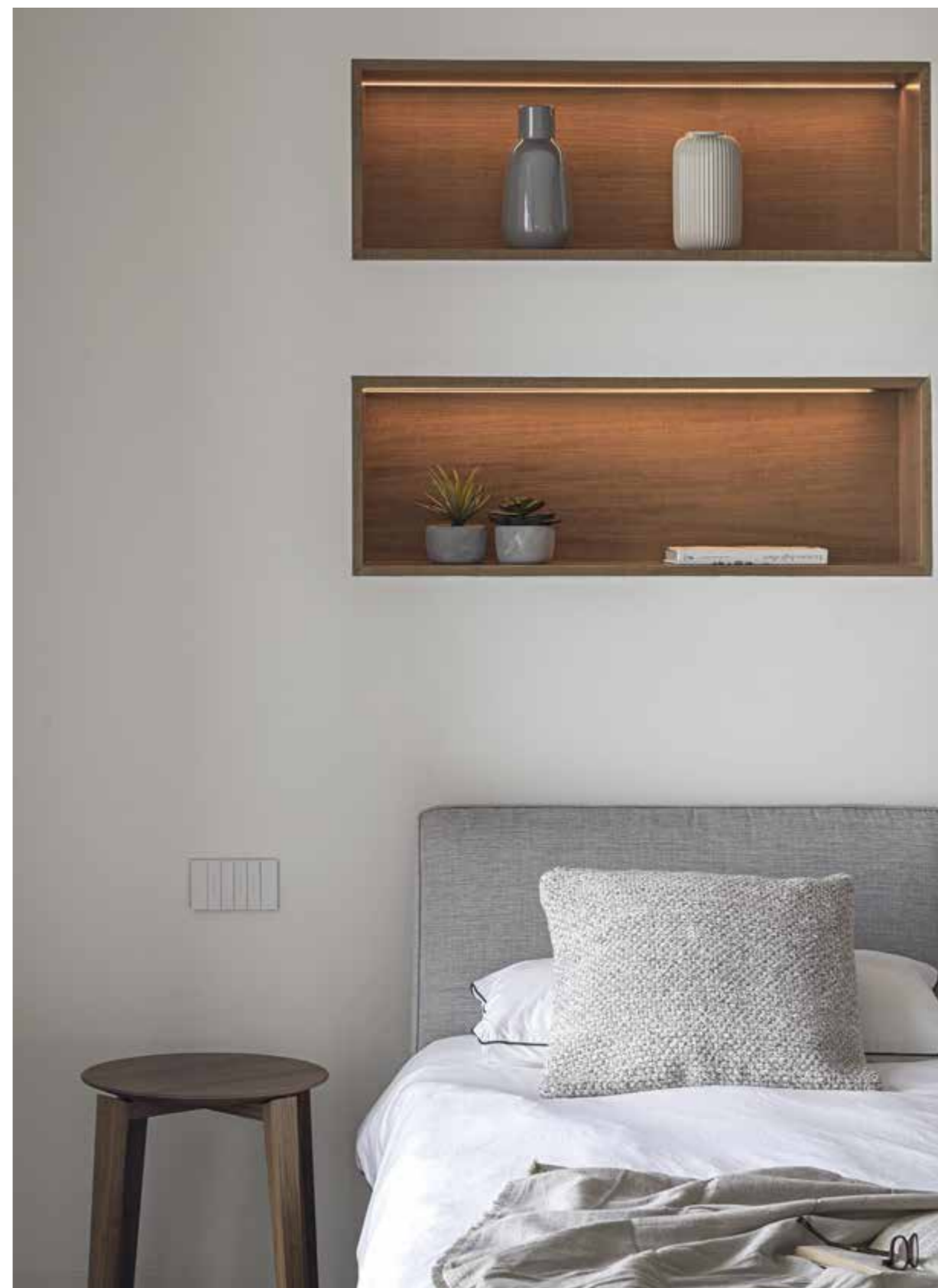



^{ITA} L'illuminazione di appartamenti mansardati rappresenta, da sempre, una grande sfida per un lighting designer. Nel caso di questo grazioso appartamento nel cuore di Milano è stato necessario riqualificare, attraverso l'illuminazione lineare con stripled e micro-profili, le zone ribassate e le grosse travi di legno scuro.

^{EN} The lighting of attic apartments has always been a great challenge for a lighting designer. In the case of this lovely apartment in the heart of Milan, the challenge was renovating the lowered areas and the large dark wooden beams through linear lighting with LED strips and micro-profiles.



Esempi di applicazioni di stripled e profili come cove lighting e dettagli di arredo.

Examples of applications of LED strips and profiles, for cove lighting and furnishing details.



Products	Pages
 38 Surface	197
 42 Surface Low	197
 43 Surface	197
 99 Surface	198
 98 Surface	198
 97 Surface	198
 96 Surface	199
 95 Surface	199
 40 Corner	200

Products	Pages
 94 Corner	200
 93 Corner	200
 39 Recessed	201
 44 Recessed Trimless	201
 45 Recessed	201
 92 Recessed	202
 91 Recessed	202
 90 Surface Flexi	203
 Stripled / LED Strips	204



Profili

Profiles

^{ITA} Profili in lega di alluminio estruso anodizzato, verniciati in bianco o nero (a seconda delle versioni), ideali per l'installazione di stripled. Ogni profilo è indicato per una specifica installazione (superficie / angolare / incasso).

Diffusori: in policarbonato resistente.
Accessori: tappi di chiusura e ganci di fissaggio.
Lunghezza standard dei profili: 2 mt (3 mt per alcune versioni).

^{EN} Profiles made of extruded anodized aluminium alloy, white or black painted (depending on the versions), ideal for LED strip mounting. Each profile is designed for a specific application (surface / corner / recessed).

Diffusers: in high resistant polycarbonate.
Accessories: closing caps and mounting clips.
Standard length of the profiles: 2 mt (3 mt for some versions).

38 SURFACE



Codice Code	Colore profilo Profile colour	Colore cover Diffuser colour	Lunghezza Length (mm)
Completo di 4 ganci di fissaggio e 4 tappi di chiusura (2+2) Complete with 4 fixing clips and 4 closing caps (2+2)			
K7382-S04-3162	Bianco / White	Opale / Opal	2000
K7382-S04-4262	Anodizzato / Anodized	Opale / Opal	2000
K7382-S04-4247	Anodizzato / Anodized	Semi trasparente Semi-frosted	2000
K7384-S04-3162	Bianco / White	Opale / Opal	3000
K7384-S04-4262	Anodizzato / Anodized	Opale / Opal	3000

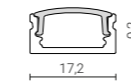

42 SURFACE LOW



Codice Code	Colore profilo Profile colour	Colore cover Diffuser colour	Lunghezza Length (mm)
Completo di 4 ganci di fissaggio e 4 tappi di chiusura (2+2) Complete with 4 fixing clips and 4 closing caps (2+2)			
K7422-04-3162	Bianco / White	Opale / Opal	2000
K7422-04-4262	Anodizzato / Anodized	Opale / Opal	2000

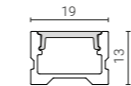

43 SURFACE



Codice Code	Colore profilo Profile colour	Colore cover Diffuser colour	Lunghezza Length (mm)
Completo di 4 ganci di fissaggio e 4 tappi di chiusura (2+2) Complete with 4 fixing clips and 4 closing caps (2+2)			
K7432-04-3162	Bianco / White	Opale / Opal	2000
K7432-04-4262	Anodizzato / Anodized	Opale / Opal	2000

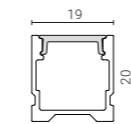

Accessori / Accessories

84-90380
Kit di ricambio con 4 ganci di fissaggio e 4 tappi di chiusura (2+2) per Profilo 38 Surface / Spare parts kit with 4 clips and 4 closing caps (2+2) for Profile 38 Surface



84-90420
Kit di ricambio con 4 ganci di fissaggio e 4 tappi di chiusura (2+2) per Profilo 42 Surface / Spare parts kit with 4 fixing clips and 4 closing caps (2+2) for Profile 42 Surface Low.



84-90430
Kit di ricambio con 4 ganci di fissaggio e 4 tappi di chiusura (2+2) per Profilo 43 Surface / Spare parts kit with 4 clips and 4 closing caps (2+2) for Profile 43 Surface



99 SURFACE



Codice Code	Colore profilo Profile colour	Colore cover Diffuser colour	Colore gancio Clip colour	Lunghezza Length (mm)
-------------	-------------------------------	------------------------------	---------------------------	-----------------------

Completo di 2 ganci di fissaggio e 2 tappi di chiusura
Complete with 2 fixing clips and 2 closing caps

K7992-S04-4262	Anodizzato / Anodized	Opale / Opal	Metal / Silver	2000
K7992-S04-3162	Bianco / White	Opale / Opal	Trasparente / Clear	2000
K7992-S04-1262	Nero / Black	Opale / Opal	Trasparente / Clear	2000

Microprofilo adatto per il solo utilizzo della speciale stripled 4mm 180LED/m 11W/m IP20 (vedi pag. 55) / Microprofile suitable only for special 4mm LED Strips 24Vdc 180LED/m 11W/m IP20 (see page 55)

1

98 SURFACE

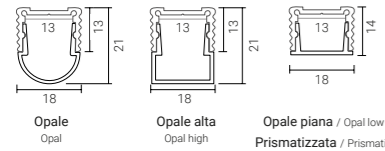

Codice Code	Colore profilo Profile colour	Colore cover Diffuser colour	Lunghezza Length (mm)
-------------	-------------------------------	------------------------------	-----------------------

Completo di 2 ganci di fissaggio e 2 tappi di chiusura
Complete with 2 fixing clips and 2 closing caps

K7982-S12-4262	Anodizzato / Anodized	Opale alta / Opal high	2000
K7982-S12-3162	Bianco / White	Opale alta / Opal high	2000
K7982-S12-1262	Nero / Black	Opale alta / Opal high	2000

K7982-S13-4262	Anodizzato / Anodized	Opale piana / Opal low	2000
K7982-S13-3162	Bianco / White	Opale piana / Opal low	2000
K7982-S13-1262	Nero / Black	Opale piana / Opal low	2000

K7982-S04-4262	Anodizzato / Anodized	Opale / Opal	2000
K7982-S04-3162	Bianco / White	Opale / Opal	2000
K7982-S04-1262	Nero / Black	Opale / Opal	2000

K7982-S11-4247	Anodizzato / Anodized	Prismatizzata / Prismatic	2000
K7982-S11-3147	Bianco / White	Prismatizzata / Prismatic	2000
K7982-S11-1247	Nero / Black	Prismatizzata / Prismatic	2000

1

97 SURFACE

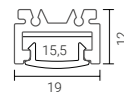

Codice Code	Colore profilo Profile colour	Colore cover Diffuser colour	Lunghezza Length (mm)
-------------	-------------------------------	------------------------------	-----------------------

Completo di 2 ganci di fissaggio e 2 tappi di chiusura
Complete with 2 fixing clips and 2 closing caps

K7972-S04-4262	Anodizzato / Anodized	Opale / Opal	2000
K7972-S04-3162	Bianco / White	Opale / Opal	2000
K7972-S04-1262	Nero / Black	Opale / Opal	2000

K7972-S04-4247	Anodizzato / Anodized	Trasparente / Clear	2000
K7972-S04-3147	Bianco / White	Trasparente / Clear	2000
K7972-S04-1247	Nero / Black	Trasparente / Clear	2000

K7972-S09-4247	Anodizzato / Anodized	Lenticolare / Lenticular	2000
K7972-S09-3147	Bianco / White	Lenticolare / Lenticular	2000
K7972-S09-1247	Nero / Black	Lenticolare / Lenticular	2000

1

96 SURFACE

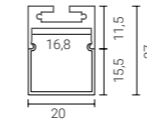

Codice Code	Colore profilo Profile colour	Colore cover Diffuser colour	Lunghezza Length (mm)
-------------	-------------------------------	------------------------------	-----------------------

Completo di 2 ganci di fissaggio e 2 tappi di chiusura. Cover in PMMA
Complete with 2 fixing clips and 2 closing caps. PMMA diffuser

K7962-S04-4262	Anodizzato / Anodized	Opale / Opal	2000
K7962-S04-3162	Bianco / White	Opale / Opal	2000
K7962-S04-1262	Nero / Black	Opale / Opal	2000

1

95 SURFACE

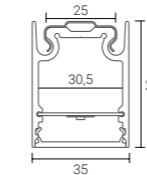

Codice Code	Colore profilo Profile colour	Colore cover Diffuser colour	Lunghezza Length (mm)
-------------	-------------------------------	------------------------------	-----------------------

Completo di 2 ganci di fissaggio e 2 tappi di chiusura
Complete with 2 fixing clips and 2 closing caps

K7952-S04-4262	Anodizzato / Anodized	Opale / Opal	2000
K7952-S04-3162	Bianco / White	Opale / Opal	2000
K7952-S04-1262	Nero / Black	Opale / Opal	2000

K7952-S11-4247	Anodizzato / Anodized	Prismatizzata / Prismatic	2000
K7952-S11-3147	Bianco / White	Prismatizzata / Prismatic	2000
K7952-S11-1247	Nero / Black	Prismatizzata / Prismatic	2000

1

40 CORNER

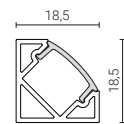

Codice Code	Colore profilo Profile colour	Colore cover Diffuser colour	Lunghezza Length (mm)
Completo di 4 ganci di fissaggio e 4 tappi di chiusura (2+2) Complete with 4 fixing clips and 4 closing caps (2+2)			
K7402-C04-3162	Bianco / White	Opale / Opal	2000
K7402-C04-4262	Anodizzato / Anodized	Opale / Opal	2000
K7402-C04-4247	Anodizzato / Anodized	Semi trasparente Semi-frosted	2000
K7404-C04-3162	Bianco / White	Opale / Opal	3000
K7404-C04-4262	Anodizzato / Anodized	Opale / Opal	3000

10

94 CORNER

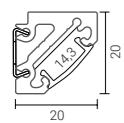

Codice Code	Colore profilo Profile colour	Colore cover Diffuser colour	Lunghezza Length (mm)
Completo di 2 ganci di fissaggio e 2 tappi di chiusura Complete with 2 fixing clips and 2 closing caps			
K7942-C04-4262	Anodizzato / Anodized	Opale / Opal	2000
K7942-C04-3162	Bianco / White	Opale / Opal	2000
K7942-C04-1262	Nero / Black	Opale / Opal	2000
K7942-C04-4247	Anodizzato / Anodized	Trasparente / Clear	2000
K7942-C04-3147	Bianco / White	Trasparente / Clear	2000
K7942-C04-1247	Nero / Black	Trasparente / Clear	2000
K7942-C09-4247	Anodizzato / Anodized	Lenticolare / Lenticular	2000
K7942-C09-3147	Bianco / White	Lenticolare / Lenticular	2000
K7942-C09-1247	Nero / Black	Lenticolare / Lenticular	2000

1

93 CORNER

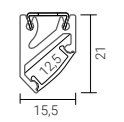

Codice Code	Colore profilo Profile colour	Colore cover Diffuser colour	Lunghezza Length (mm)
Completo di 2 ganci di fissaggio e 2 tappi di chiusura Complete with 2 fixing clips and 2 closing caps			
K7932-C04-4262	Anodizzato / Anodized	Opale / Opal	2000
K7932-C04-3162	Bianco / White	Opale / Opal	2000
K7932-C04-1262	Nero / Black	Opale / Opal	2000
K7932-C04-4247	Anodizzato / Anodized	Trasparente / Clear	2000
K7932-C04-3147	Bianco / White	Trasparente / Clear	2000
K7932-C04-1247	Nero / Black	Trasparente / Clear	2000

1

Accessori / Accessories

84-90400

Kit di ricambio con 4 ganci di fissaggio e 4 tappi di chiusura (2+2) per Profilo 40 Corner / Spare parts kit with 4 clips and 4 closing caps (2+2) for Profile 40 Corner

31 51

- 200

39 RECESSED

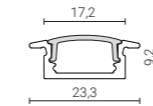

Codice Code	Colore profilo Profile colour	Colore cover Cover colour	Lunghezza Length (mm)
Completo di 4 ganci di fissaggio e 4 tappi di chiusura (2+2) Complete with 4 fixing clips and 4 closing caps (2+2)			
K7392-R04-3162	Bianco / White	Opale / Opal	2000
K7392-R04-4262	Anodizzato / Anodized	Opale / Opal	2000
K7394-R04-4262	Anodizzato / Anodized	Opale / Opal	3000

20

44 RECESSED TRIMLESS

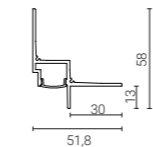

Codice Code	Colore profilo Profile colour	Colore cover Cover colour	Lunghezza Length (mm)
K7443-R04-3147	Bianco / White	Semi trasparente Semi-frosted	3000

2

45 RECESSED

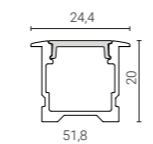
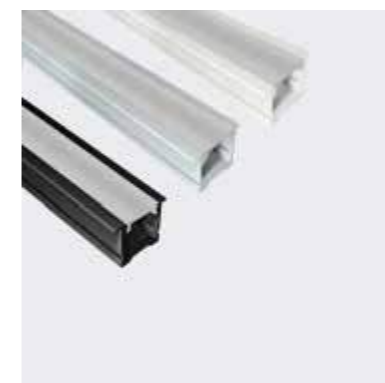

Codice Code	Colore profilo Profile colour	Colore cover Cover colour	Lunghezza Length (mm)
Completo di 4 ganci di fissaggio e 4 tappi di chiusura (2+2) Complete with 4 fixing clips and 4 closing caps (2+2)			
K7452-04-3162	Bianco / White	Opale / Opal	2000
K7452-04-4262	Anodizzato / Anodized	Opale / Opal	2000
K7452-04-1262	Nero / Black	Opale / Opal	2000

12

Accessori / Accessories

84-90390

Kit di ricambio con 4 ganci di fissaggio e 4 tappi di chiusura (2+2) per Profilo 39 Recessed / Spare parts kit with 4 clips and 4 closing caps (2+2) for Profile 39 Recessed

31 51

84-90450

Kit di ricambio con 4 ganci di fissaggio e 4 tappi di chiusura (2+2) per Profilo 45 Recessed / Spare parts kit with 4 clips and 4 closing caps (2+2) for Profile 45 Recessed

30 31 51

92 RECESSED



Codice Code	Colore profilo Profile colour	Colore cover Diffuser colour	Lunghezza Length (mm)
Completo di 2 ganci di fissaggio e 2 tappi di chiusura Complete with 2 fixing clips and 2 closing caps			
K7922-R04-4262	Anodizzato / Anodized	Opale / Opal	2000
K7922-R04-3162	Bianco / White	Opale / Opal	2000
K7922-R04-1262	Nero / Black	Opale / Opal	2000
K7922-R04-4247	Anodizzato / Anodized	Trasparente / Clear	2000
K7922-R04-3147	Bianco / White	Trasparente / Clear	2000
K7922-R04-1247	Nero / Black	Trasparente / Clear	2000

1

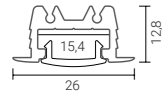

91 RECESSED



Codice Code	Colore profilo Profile colour	Colore cover Diffuser colour	Lunghezza Length (mm)
Completo di 2 ganci di fissaggio e 2 tappi di chiusura Complete with 2 fixing clips and 2 closing caps			
K7912-R04-4262	Anodizzato / Anodized	Opale / Opal	2000
K7912-R04-3162	Bianco / White	Opale / Opal	2000
K7912-R04-1262	Nero / Black	Opale / Opal	2000
K7912-R11-4247	Anodizzato / Anodized	Prismatizzata / Prismatic	2000
K7912-R11-3147	Bianco / White	Prismatizzata / Prismatic	2000
K7912-R11-1247	Nero / Black	Prismatizzata / Prismatic	2000

1

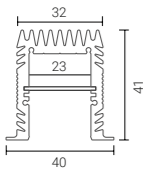

90 SURFACE FLEXI



Codice Code	Colore profilo Profile colour	Colore cover Diffuser colour	Lunghezza Length (mm)
Profilo in alluminio anodizzato flessibile. Completo di 2 ganci di fissaggio e 2 tappi di chiusura / Flexible anodized aluminium profile. Complete with 2 fixing clips and 2 closing caps			
K7902-S04-4262	Anodizzato / Anodized	Opale / Opal	2000
K7902-S04-3162	Bianco / White	Opale / Opal	2000
K7902-S04-1262	Nero / Black	Opale / Opal	2000

1

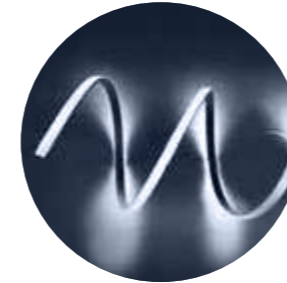
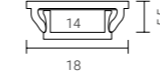

Profilo 90 Surface Flexi acceso
90 Surface Flexi profile switched on



STRIP LED 180



Codice Code	Watt/mt	Lumen/mt	LED/mt	Colour T (K)	CRI	Fascio Beam
Driver da ordinare separatamente / Driver should be ordered separately						
93-05087-20	11	1280	180	3000	80	120°
93-05088-20	11	1340	180	4000	80	120°
93-05089-20	11	5800	180	5800	80	120°

Stripled ideale per Profilo 99 Surface (vedi pag. 198)
LED Strip ideal for 99 Surface Profile (see page 198)

CE IP20 24Vdc

Driver da ordinare separatamente / Driver should be ordered separately

- 91-02603** Output 24Vdc 100 W
Tensione costante / Constant voltage
- 91-90032** Output 24Vdc
Tensione costante / Constant voltage
- 91-02604** Output 24Vdc 200 W
Tensione costante / Constant voltage

Stripled

LED Strips

^{ITA} Stripled professionali con alimentazione 24VDC semplici da installare su profili dissipanti in alluminio. Sono fornite in bobine da 5 metri e sono complete di biadesivo 3M. Possono essere sezionate a interassi prefissati con un cutter. Ideali per illuminare ambienti, creando un effetto luminoso decorativo. L'elevato numero di LED per metro consente un'ottima e uniforme distribuzione della luce in qualsiasi condizione di regolazione luminosa.

La temperatura colore indicata per le stripled IP65 è rilevata dalle stripled IP20 e potrebbe subire delle variazioni. Installare le stripled con il punto di connessione / giunzione in zona protetta dall'acqua.

^{EN} Professional LED stripes with 24VDC voltage, easy to be installed on dissipating aluminium profiles. The LED stripes are supplied in 5 meters coils and include 3M double-sided tape. They can be cut at predetermined interaxal spacings with a cutter. Ideal for illumination with a decorative luminous effect. The great number of LEDs per meter allows an excellent and uniform light distribution in any condition of light regulation.

Colour temperature for IP65 LED strips is measured from IP20 LED strips and might be subject to changes. LED strips must be installed keeping the connection / junction point in a water-protected position.

STRIP LED 154



Per driver consultare pag 205
For drivers look at pag. 205

Codice Code	Watt/mt	Lumen/mt	LED/mt	Colour T (K)	CRI	Fascio Beam
Driver da ordinare separatamente / Driver should be ordered separately						
93-1540522-20	5	462	154	2200	90	120°
93-1540527-20	5	570	154	2700	90	120°
93-1540530-20	5	600	154	3000	90	120°
93-1540535-20	5	616	154	3500	90	120°
93-1540540-20	5	647	154	4000	90	120°
93-1540550-20	5	680	154	5000	90	120°
93-1540565-20	5	647	154	6500	90	120°
93-1540922-20	9	924	154	2200	90	120°
93-1540927-20	9	1110	154	2700	90	120°
93-1540930-20	9	1155	154	3000	90	120°
93-1540935-20	9	1190	154	3500	90	120°
93-1540940-20	9	1232	154	4000	90	120°
93-1540950-20	9	1265	154	5000	90	120°
93-1540965-20	9	1232	154	6500	90	120°
93-1541322-20	13	1386	154	2200	90	120°
93-1541327-20	13	1586	154	2700	90	120°
93-1541330-20	13	1648	154	3000	90	120°
93-1541335-20	13	1703	154	3500	90	120°
93-1541340-20	13	1756	154	4000	90	120°
93-1541350-20	13	1800	154	5000	90	120°
93-1541365-20	13	1756	154	6500	90	120°

CE IP20 24Vdc

STRIP LED 154 IP65



Per driver consultare pag 205
For drivers look at pag. 205

Codice Code	Watt/mt	Lumen/mt	LED/mt	Colour T (K)	CRI	Fascio Beam
Driver da ordinare separatamente / Driver should be ordered separately						
93-1540522-65	5	462	154	2200	90	120°
93-1540527-65	5	570	154	2700	90	120°
93-1540530-65	5	600	154	3000	90	120°
93-1540535-65	5	616	154	3500	90	120°
93-1540540-65	5	647	154	4000	90	120°
93-1540550-65	5	680	154	5000	90	120°
93-1540565-65	5	647	154	6500	90	120°
93-1540922-65	9	924	154	2200	90	120°
93-1540927-65	9	1110	154	2700	90	120°
93-1540930-65	9	1155	154	3000	90	120°
93-1540935-65	9	1190	154	3500	90	120°
93-1540940-65	9	1232	154	4000	90	120°
93-1540950-65	9	1265	154	5000	90	120°
93-1540965-65	9	1232	154	6500	90	120°
93-1541322-65	13	1386	154	2200	90	120°
93-1541327-65	13	1586	154	2700	90	120°
93-1541330-65	13	1648	154	3000	90	120°
93-1541335-65	13	1703	154	3500	90	120°
93-1541340-65	13	1756	154	4000	90	120°
93-1541350-65	13	1800	154	5000	90	120°
93-1541365-65	13	1756	154	6500	90	120°

CE IP65 24Vdc

STRIP LED 196

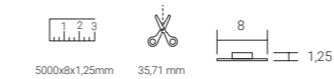

Per driver consultare pag 205
For drivers look at pag. 205

Codice Code	Watt/mt	Lumen/mt	LED/mt	Colour T (K)	CRI	Fascio Beam
Driver da ordinare separatamente / Driver should be ordered separately						
93-1968522-20	8,5	980	196	2200	90	120°
93-1968527-20	8,5	1078	196	2700	90	120°
93-1968530-20	8,5	1117	196	3000	90	120°
93-1968535-20	8,5	1160	196	3500	90	120°
93-1968540-20	8,5	1195	196	4000	90	120°
93-1968550-20	8,5	1230	196	5000	90	120°
93-1968565-20	8,5	1200	196	6500	90	120°
93-1961627-20	16	1940	196	2700	90	120°
93-1961630-20	16	2038	196	3000	90	120°
93-1961635-20	16	2040	196	3500	90	120°
93-1961640-20	16	2156	196	4000	90	120°
93-1961650-20	16	2205	196	5000	90	120°
93-1961665-20	16	2156	196	6500	90	120°
93-1962427-20	24,5	2783	196	2700	90	120°
93-1962430-20	24,5	2920	196	3000	90	120°
93-1962435-20	24,5	2940	196	3500	90	120°
93-1962440-20	24,5	3096	196	4000	90	120°
93-1962450-20	24,5	3180	196	5000	90	120°
93-1962465-20	24,5	3097	196	6500	90	120°

CE IP20 24Vdc

STRIP LED 196 IP65

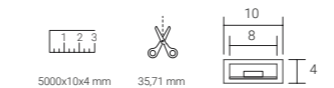

Per driver consultare pag 205
For drivers look at pag. 205

Codice Code	Watt/mt	Lumen/mt	LED/mt	Colour T (K)	CRI	Fascio Beam
Driver da ordinare separatamente / Driver should be ordered separately						
93-1968522-65	8,5	980	196	2200	90	120°
93-1968527-65	8,5	1078	196	2700	90	120°
93-1968530-65	8,5	1117	196	3000	90	120°
93-1968535-65	8,5	1160	196	3500	90	120°
93-1968540-65	8,5	1195	196	4000	90	120°
93-1968550-65	8,5	1230	196	5000	90	120°
93-1968565-65	8,5	1200	196	6500	90	120°
93-1961627-65	16	1940	196	2700	90	120°
93-1961630-65	16	2038	196	3000	90	120°
93-1961635-65	16	2040	196	3500	90	120°
93-1961640-65	16	2156	196	4000	90	120°
93-1961650-65	16	2205	196	5000	90	120°
93-1961665-65	16	2156	196	6500	90	120°
93-1962427-65	24,5	2783	196	2700	90	120°
93-1962430-65	24,5	2920	196	3000	90	120°
93-1962435-65	24,5	2940	196	3500	90	120°
93-1962440-65	24,5	3096	196	4000	90	120°
93-1962450-65	24,5	3180	196	5000	90	120°
93-1962465-65	24,5	3097	196	6500	90	120°

CE IP65 24Vdc

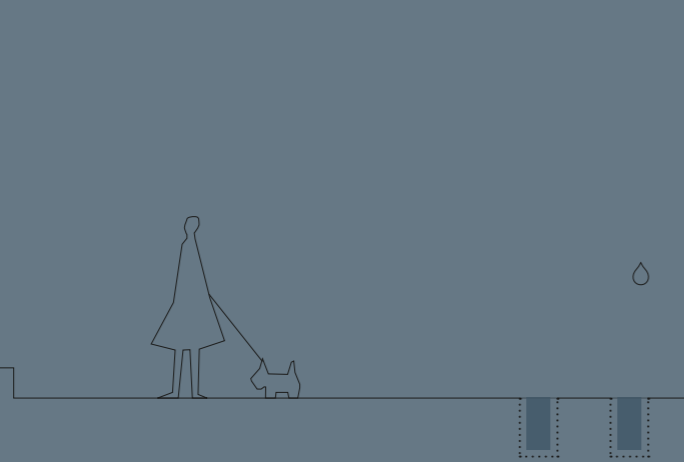

Una guida affidabile verso il palcoscenico

A reliable guide toward the stage

^{ITA} Gli incassi da terra per esterni segnano il percorso della luce, orientando il cammino. Caratterizzati da un'estetica minimal garantiscono un'ottima qualità della luce ovunque siano collocati. Illuminano gli spazi verdi e zone di passaggio, valorizzando le architetture del contesto.

^{EN} The exterior inground lights mark a path of light, directing the way or lighting up walls and columns. Featuring a minimal design, and a very small recess depth, they offer excellent quality of light wherever they are placed.



Gli incassi calpestabili Perfetto In-Ground valorizzano le architetture e le zone di passaggio.
The walkover inground uplights Perfetto In-Ground enhance architectures and walkways.



^{ITA} Hanno una ridotta profondità di incasso e una moderna cornice in acciaio inox. Adatti per essere utilizzati in ambienti esterni e interni, possono essere incassati a pavimento, parete o soffitto, per effetti luminosi scenografici.

Grado di protezione IP68 1m. L'elevato grado di protezione IP e il trattamento dei materiali rendono questi prodotti ideali per l'esterno.

^{EN} The uplights have a shallow recessed depth and a stainless steel frame with the highest IP rating of IP68 1m. Suitable for both exterior and interior use; recessed in the floor, wall or ceiling. The high protection rating and the finishing of the materials make these fittings ideal for exterior applications.



Achille 320 LED

^{ITA} La gamma Achille è composta da apparecchi da incasso a filo terreno in grado di evidenziare le architetture e i luoghi naturali mettendoli in risalto e creando, allo stesso tempo, atmosfere d'effetto. Sono ideali per illuminare facciate di edifici, monumenti, giardini. Calpestabili e carrabili, sono costruiti con materiali altamente resistenti agli agenti di corrosione e possiedono un elevato grado di protezione (IP67). Per questo motivo risultano affidabili nel tempo e adatti per applicazioni in esterno, anche in condizioni atmosferiche particolarmente gravose.

^{EN} The Achille range consists of flush-to-ground recessed luminaires for highlighting architecture and natural places and creating, at the same time, captivating atmospheres. They are ideal for illuminating the façades of buildings, monuments, and gardens. They are walkable and drive-over and built with materials that are highly resistant to corrosion agents and have a high protection rating (IP67). For this reason, they are reliable over time and suitable for outdoor applications, even in particularly severe atmospheric conditions.



Nauto è perfettamente integrabile nella pavimentazione come luce segnapasso e decorativa. La versione con lente in PMMA rende il prodotto ancora più versatile.

Nauto can be perfectly fitted in the floor and it is ideal as step light and marker in many applications. The version with a PMMA lens makes the product even more versatile.

Incassi da terra
per esterni

Exterior
ingrounds



INDEX

Products

Pages



Nanoperfetto IN-Ground

214



Nanoperfetto IN-Ground asymmetric

215



Perfetto IN-Ground

216



Perfetto IN-Ground asymmetric

217



Nauto

218



Achille 190 LED

219



Achille 320 LED

220



Achille 450 LED

221

NANOPERFETTO IN - GROUND CON LENTE / WITH LENS

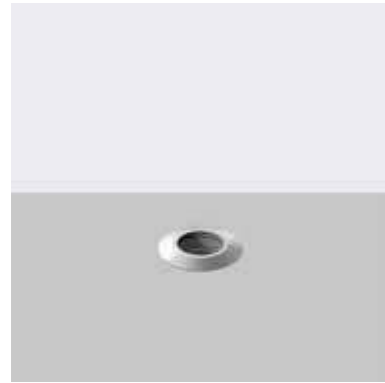

Codice Code	LED Lumen	Product Lumen	Watt	mA	Colour T (K)	CRI	Fascio Beam
-------------	-----------	---------------	------	----	--------------	-----	-------------

Con molle e controcassa per installazione a terra come calpestabile. Con lente non sostituibile
With springs and recessed housing for in-ground installation as a walk-over fitting. With not replaceable lens

1528000	350	315	3	700	3000	90	14°
1528BV000	350	315	3	700	3000	90	45°
1528C000	350	315	3	700	2700	90	14°
1528CV000	350	315	3	700	2700	90	45°

Driver da ordinare separatamente / Driver should be ordered separately

81-02531 Output 700mA - max 3 apparecchi / max 3 fittings
Corrente costante / Constant current

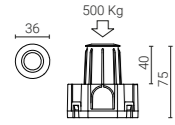

NANOPERFETTO IN - GROUND CON LENTE / WITH LENS

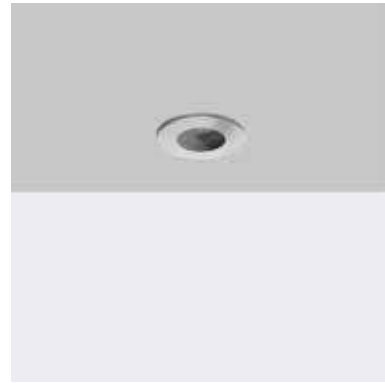

Codice Code	LED Lumen	Product Lumen	Watt	mA	Colour T (K)	CRI	Fascio Beam
-------------	-----------	---------------	------	----	--------------	-----	-------------

Con molle per installazione in pannellature e controsoffitti. Con lente non sostituibile
With springs for panelling and false ceiling mounting. With not replaceable lens

1528010	350	315	3	700	3000	90	14°
1528BV010	350	315	3	700	3000	90	45°
1528C010	350	315	3	700	2700	90	14°
1528CV010	350	315	3	700	2700	90	45°

Driver da ordinare separatamente / Driver should be ordered separately

81-02531 Output 700mA - max 3 apparecchi / max 3 fittings
Corrente costante / Constant current

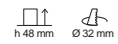

Accessori su richiesta / Accessories on demand

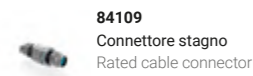

84109
Connettore stagno
Rated cable connector



28-4567-00
Cornice quadra
Square frame

Accessori ottici intercambiabili / Replaceable optical accessories



28-4327-30
Frangiluce alveolare
Honeycomb

NANOPERFETTO IN - GROUND ASIMMETRICO / ASYMMETRIC

Incassi da terra per esterni Exterior ingrounds

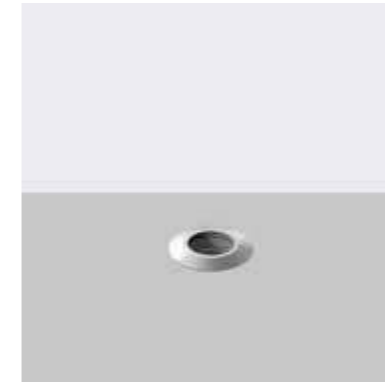

Codice Code	LED Lumen	Product Lumen	Watt	mA	Colour T (K)	CRI	Fascio Beam
-------------	-----------	---------------	------	----	--------------	-----	-------------

Con molle e controcassa per installazione a terra come calpestabile
With springs and recessed housing for in-ground installation as a walk-over fitting

1528100	350	315	3	700	3000	90	Asimmetrico Asymmetric
----------------	-----	-----	---	-----	------	----	---------------------------

Driver da ordinare separatamente / Driver should be ordered separately

81-02531 Output 700mA - max 3 apparecchi / max 3 fittings
Corrente costante / Constant current

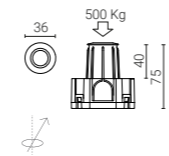

Accessori su richiesta / Accessories on demand



84109
Connettore stagno
Rated cable connector



28-4567-00
Cornice quadra
Square frame

PERFETTO IN - GROUND
CON LENTE / WITH LENS



Codice Code	LED Lumen	Product Lumen	Watt	mA	Colour T (K)	CRI	Fascio Beam
Con lente non sostituibile With not replaceable lens							
1456000	534	-	4	350	3000	85	21°
	602	-	4,7	400	3000	85	21°

Driver da ordinare separatamente / Driver should be ordered separately

81-04020 Output 350mA - max 3 apparecchi / max 3 fittings

81-04056 Output 400mA - max 3 apparecchi / max 3 fittings

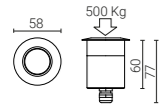

0,7 Kg

PERFETTO IN - GROUND



Codice Code	LED Lumen	Product Lumen	Watt	mA	Colour T (K)	CRI	Fascio Beam
1455000	785	550	6,5	700	3000	80	34°
1455BV000	785	550	6,5	700	3000	80	52°

Driver da ordinare separatamente / Driver should be ordered separately

81-04065 Output 700mA (IP67) - max 2 apparecchi / max 2 fittings

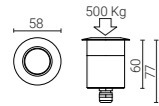

0,7 Kg

Accessori ottici intercambiabili solo per Perfetto IN - Ground con lente
Replaceable optical accessories only for Perfetto IN - Ground with lens

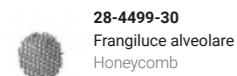

28-4499-30
Frangiluce alveolare
Honeycomb



28-4499-47
Vetro zigrinato
Prismatic spread lens

Accessori ottici intercambiabili solo per Perfetto IN - Ground
Replaceable optical accessories only for Perfetto IN - Ground

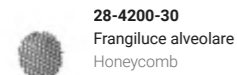

28-4200-30
Frangiluce alveolare
Honeycomb



28-4177-4730
Vetro trasparente semi serigrafato
nero, effetto antiabbagliante
Black silk-screened clear glass,
with anti-dazzling effect



28-4177-47
Vetro zigrinato
Prismatic spread lens

Accessori su richiesta / Accessories on demand



28-4195-30
Controcassa per installazione
come calpestabile / Recessed
housing for installation in-ground



28-4197-48
Molle per montaggio in
controsoffitti e pannellature
Springs for false ceilings and
panelling mounting



160821
Bobina di cavo di alimentazione
H05RN-F, 2x1mm², 10 mt
10 mt supply cable coil H05RN-F
2x1mm²



84108
Connettore stagno
Rated cable connector

PERFETTO IN - GROUND
ASIMMETRICO / ASYMMETRIC

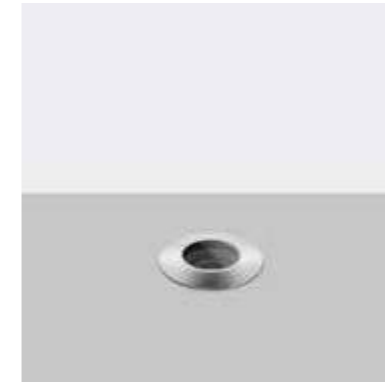

Codice Code	LED Lumen	Product Lumen	Watt	mA	Colour T (K)	CRI	Fascio Beam
1453100	350	-	3	700	3000	80	Asimmetrico Asymmetric

Driver da ordinare separatamente / Driver should be ordered separately

81-04065 Output 700mA (IP67) - max 4 apparecchi / max 4 fittings

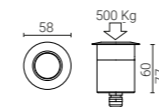

0,7 Kg



Accessori su richiesta / Accessories on demand



28-4195-30
Controcassa per installazione
come calpestabile / Recessed
housing for installation in-ground



28-4197-48
Molle per montaggio in
controsoffitti e pannellature
Springs for false ceilings and
panelling mounting



160821
Bobina di cavo di alimentazione
H05RN-F, 2x1mm², 10 mt
10 mt supply cable coil H05RN-F
2x1mm²



84108
Connettore stagno
Rated cable connector

NAUTO
CON LENTE / WITH LENS



Codice Code	Linea Line	LED Lumen	Product Lumen	Watt	mA	Colour T (K)	CRI	Fascio Beam
Con lente in PMMA e controcassa inclusa With PMMA lens and recessed housing included								
1557BZ110	1	600	-	4,7	400	3000	80	14°
1557BW110	1	600	-	4,7	400	3000	80	36°
1557BZ210	2	600	-	4,7	400	3000	80	14°
1557BW210	2	600	-	4,7	400	3000	80	36°

Driver da ordinare separatamente / Driver should be ordered separately

81-04056 Output 400mA

CE RoHS IP67 IK10

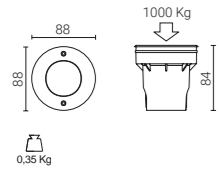

NAUTO



Codice Code	LED Lumen	Product Lumen	Watt	mA V _{dc}	Colour T (K)	CRI	T max (°C)
Controcassa in dotazione nell'apparecchio Recessed housing included in the fitting							
1563180	300 (3 LED)	-	3	350	3000 bianco / white	80	55°
1543180	180 (9 LED)	-	1,5	24	3500 bianco / white	80	40°
1546480	-(9 LED)	-	1,5	24	- blu / blue	-	40°

Driver da ordinare separatamente / Driver should be ordered separately

81-04020 Output 350mA (15W) - max 4 apparecchi / max 4 fittings
Corrente costante / Constant current
distanza massima da driver 30 m / max distance from driver 30 m

81-04006 Output 24V_{dc} (20W) - max 12 apparecchi / max 12 fittings
Corrente costante / Constant current
distanza massima da driver 30 m / max distance from driver 30 m

CE RoHS IP68 IK10

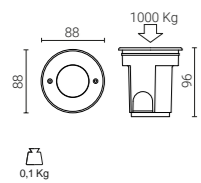

Accessori/ Accessories



160821
Bobina di cavo di alimentazione
H05RN-F, 2x1mm², 10 mt
10 mt supply cable coil H05RN-F
2x1mm²



84108
Connettore stagno
Rated cable connector

ACHILLE 190 LED

Incassi da terra per esterni Exterior ingrounds



Codice Code	LED Lumen	Product Lumen	Watt	Colour T (K)	CRI	T max (°C)	Fascio Beam
Controcassa in dotazione nell'apparecchio. Ottica orientabile +/-7° Recessed housing included in the fitting +/-7° adjustable reflector							
149401	1800	1530	12	3000	85	40°	26°
149501	2500	2125	18	3000	85	40°	26°

12W: Regolabile sulla fase / Dimmable on the mains
220/240V - 50/60Hz

CE RoHS IP67 IK10

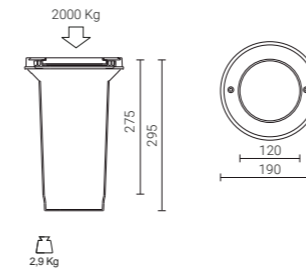

Accessori ottici intercambiabili / Replaceable optical accessories



28-9001-51
Ottica professionale S
Professional optic device S
Fascio / Beam: 15°



28-9003-51
Ottica professionale W
Professional optic device W
Fascio / Beam: 45°

Accessori/ Accessories



160821
Bobina di cavo di alimentazione
H05RN-F, 2x1mm², 10 mt
10 mt supply cable coil H05RN-F
2x1mm²

ACHILLE 320 LED



Codice Code	LED Lumen	Product Lumen	Watt	Colour T (K)	CRI	T max (°C)	Fascio Beam
Ottica orientabile +/- 15° +/- 15° adjustable reflector							
147900	2500	1944	18	3000	85	35°	30°
148000	4100	3190	27	3000	85	35°	25°
146200	4300	3344	32	3000	85	35°	30°
146300	5300	4121	36	3000	85	35°	25°

160348
Controcassa da ordinare separatamente
Recessed housing to be ordered separately

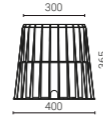

220/240V - 50/60Hz

CE IP67 IK10

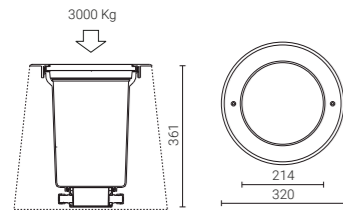

7,2 Kg

Accessori ottici intercambiabili / Replaceable optical accessories



28-3140-51
Ottica professionale S (diffusore incluso)
Professional optic device S (included diffuser)
Fascio / Beam: 17° (18W / 32W)
Fascio / Beam: 25° (27W / 36W)



28-3142-51
Ottica professionale M
Professional optic device M
Fascio / Beam: 30° (18W / 32W)
Fascio / Beam: 40° (27W / 36W)



28-3138-51
Ottica professionale W
Professional optic device W
Fascio / Beam: 55° (18W / 32W)
Fascio / Beam: 60° (27W / 36W)



28-3141-31
Ottica professionale XW
Professional optic device XW
Fascio / Beam: 70°



28-3957-30
Cilindro antiabbagliamento
Snoot



28-3959-30
Frangiluce alveolare (da utilizzare insieme a snoot cod. 28-3957-30)
Honeycomb (to be used with snoot code 28-3957-30)

ACHILLE 450 LED



Codice Code	LED Lumen	Product Lumen	Watt	mA	Colour T (K)	CRI	Fascio Beam
Orientamento del vano ottico di 12° The reflector can be adjusted up to 12°							
147000	6800	5772	51	3000	85	40°	25°

160349
Controcassa da ordinare separatamente
Recessed housing to be ordered separately

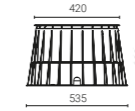

230/240V - 50/60Hz

CE IP67 IK10

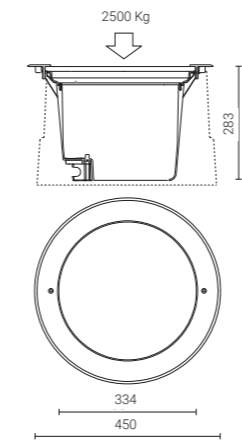

11,8 Kg

Accessori ottici intercambiabili / Replaceable optical accessories



28-3142-51
Ottica professionale M
Professional optic device M
Fascio / Beam: 40°



28-3138-51
Ottica professionale W
Professional optic device W
Fascio / Beam: 60°



28-3141-31
Ottica professionale XW
Professional optic device XW
Fascio / Beam: 70°



28-3957-30
Cilindro antiabbagliamento
Snoot



28-3959-30
Frangiluce alveolare (da utilizzare insieme a snoot cod. 28-3957-30)
Honeycomb (to be used with snoot code 28-3957-30)

Incassi da parete
per esterni

Exterior recessed
wall lights



Morbidi bagliori modellano il buio

Morbidi bagliori modellano il buio

^{ITA} Semplici e definite geometrie danno forma a soffuse ed eleganti atmosfere notturne. Il rigore del design della gamma di luci da incasso per esterni si armonizza con la morbidezza della luce emanata, valorizzando percorsi e architetture nel buio.

^{EN} Simple and defined geometries give shape to soft and elegant night-time atmospheres. The rigorous design of this range of exterior recessed wall lights harmonizes with the softness of the light, enhancing paths and architecture in the dark.

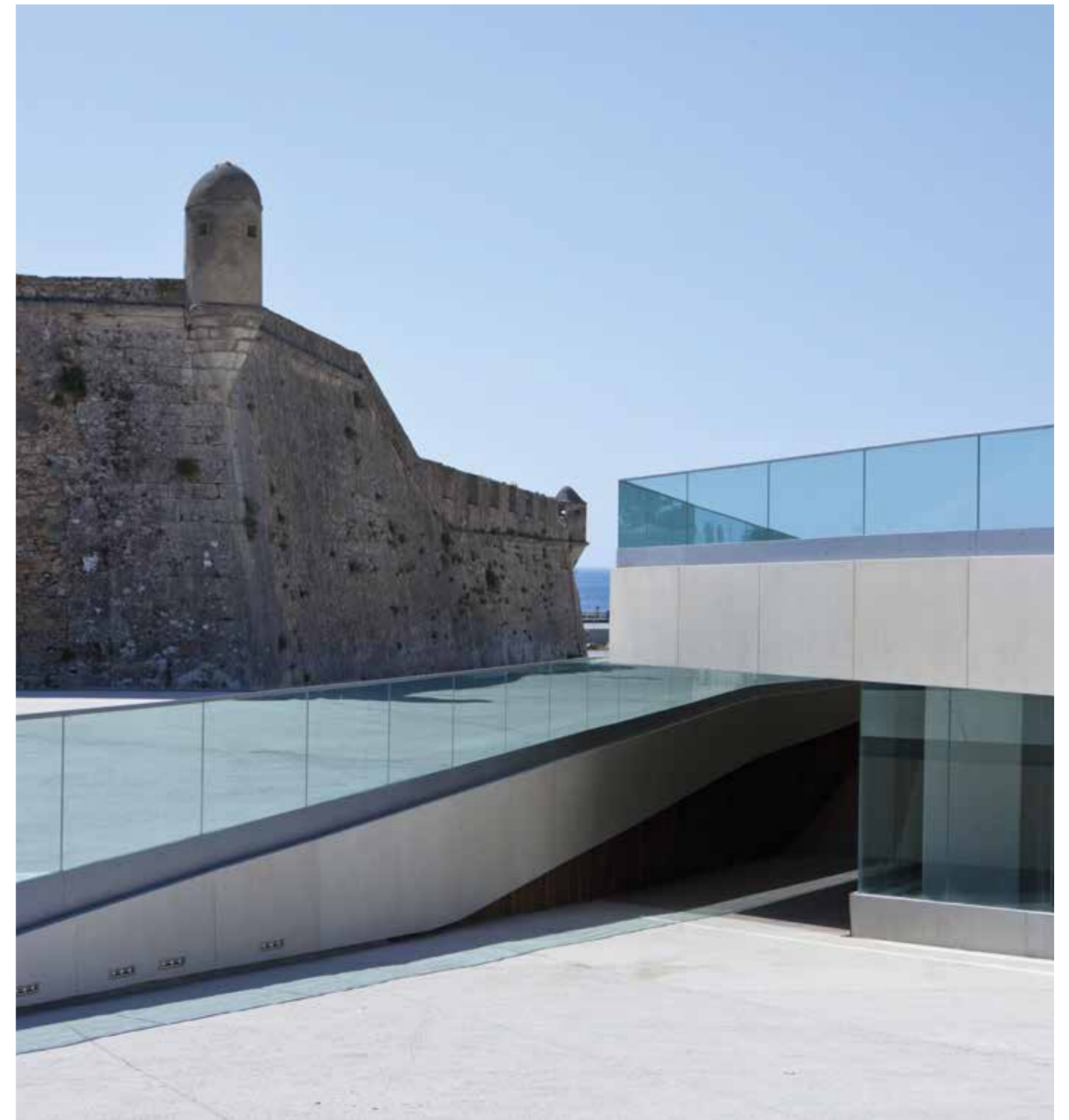

^{ITA} Stilled è un incasso dal design essenziale, applicabile sia a parete, per soluzioni scenografiche, sia a terra per scandire zone di passaggio. Calpestabile e perfettamente integrabile in ogni superficie, è utile per evidenziare percorsi e vie di uscita o per creare effetti luminosi.

^{EN} Stilled is a recessed LED fitting with an essential design. It is suitable both for wall mounting, for scenographic solutions, and for installation in the ground to mark walkways. It is suitable for the passage of pedestrians, and it can be perfectly integrated into any surface. It is useful for the safe illumination of footpaths and exit ways, or to create light effects along the walls.



I paletti Pole-Cut 80 con finitura ruggine creano la giusta atmosfera abbinati agli incassi Wall-Cut 80 con cornice bianca e piastra decorativa oro, per un'armonia di stile e funzionalità.

The Pole-Cut 80 bollards with a rust finish create the right atmosphere combined with the Wall-Cut 80 recessed fittings with white frame and gold decorative plate, for a harmony of style and functionality.

Incassi da parete
per esterni

Exterior recessed
wall lights



^{ITA} Forme discrete nascondono le viti illuminando un disegno pulito ed elegante, declinabile in molteplici finiture che permettono un alto grado di personalizzazione del progetto.

Grazie alla controcassa di dimensioni contenute, Wall Cut può essere installato in muri di spessore ridotto anche in interni.

^{EN} Discrete shapes hide the screws, illuminating a clean and elegant design, available in multiple finishes that allow a high level of customization of the project.

Wall-Cut can be installed in walls with shallow thickness, for interior use, thanks to the reduced size of the recessed housing.

^{ITA} La cornice, la piastra decorativa e il corpo interno si possono comporre per ottenere diverse combinazioni. La sottigliezza dell'apparecchio è ulteriormente enfatizzata dalla cornice che, nascondendo la fonte luminosa, crea un gioco di spessore di grande effetto visivo.

^{EN} You can mix the frame, the decorative plate, and the inner body to get different combinations. The frame creates a thick play of stunning visual effect, hiding the light source and emphasizing the thinness of the luminaire.





^{ITA} Wall-Cut 80: un taglio nello spessore della parete dà origine a incassi quadrati. Una geometria leggera ed armoniosa che enfatizza dettagli nell'oscurità.

^{EN} Wall-Cut 80: a cut in the thickness of the wall gives rise to square recessed lights. A light and harmonious geometry that emphasizes details in the dark.

Incassi da parete
per esterni

Exterior recessed
wall lights



INDEX

Products

Pages



Wall-Cut 80

230



Wall-Cut 150

231



Stilled

232

WALL-CUT 80



Codice Code	LED Lumen	Product Lumen	Watt	Colour T (K)	CRI	Fascio Beam
Corpo interno (LED + driver + controcassa) Inner body (LED + driver + recessed housing)						
151147	500	225	4,5	3000	80	α 53° / β 91°
1511C47	500	225	4,5	2700	80	α 53° / β 91°

220/240V - 50/60Hz

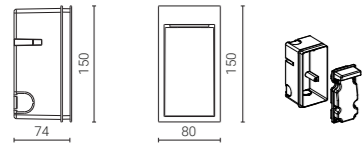

0,6 Kg

CE IP66 IK09

Corpo esterno da ordinare separatamente (cornice + piastra decorativa)
Outer body to be ordered separately (frame + decorative plate)

Codice Code	Cornice Frame	Piastra Plate
28-04093-01	Nero / Black	+ Nero / Black
28-04093-2131	Bianco / White	+ Bianco / White
28-04093-67	Ruggine / Rust	+ Ruggine / Rust
28-04093-85	Metal / Silver	+ Metal / Silver
28-04093-100	Nero / Black	+ Oro satinato / Satined gold

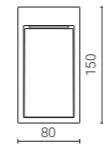

Accessori su richiesta / Accessories on demand



28-4285-00
Struttura con molle per montaggio su pannellature e cartongesso
Body with springs for panelling and plasterboard mounting

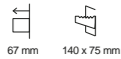

Accessori intercambiabili / Replaceable accessories



28-04094-30
Piastra decorativa nera
Black front plate



28-04094-31
Piastra decorativa bianca
White front plate



28-04094-51
Piastra decorativa metal
Silver front plate



28-04094-67
Piastra decorativa ruggine
Rust front plate



28-04094-100
Piastra decorativa oro satinato
Satined gold front plate

WALL-CUT 150

Incassi da parete per esterni

Exterior recessed wall lights



Codice Code	LED Lumen	Product Lumen	Watt	Colour T (K)	CRI	Fascio Beam
Corpo interno (LED + driver + controcassa) Inner body (LED + driver + recessed housing)						
150747	250	140	2,8	3000	90	α 53° / β 91°
150847	1000	412	9	3000	80	α 53° / β 91°
1508C47	1000	412	9	2700	80	α 53° / β 91°

220/240V - 50/60Hz

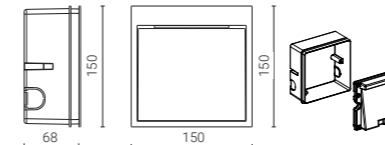

1 Kg

CE IP66 IK09

Corpo esterno da ordinare separatamente (cornice + piastra decorativa)
Outer body to be ordered separately (frame + decorative plate)

Codice Code	Cornice Frame	Piastra Plate
28-04082-01	Nero / Black	+ Nero / Black
28-04082-2131	Bianco / White	+ Bianco / White
28-04082-67	Ruggine / Rust	+ Ruggine / Rust
28-04082-85	Metal / Silver	+ Metal / Silver

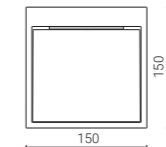

Accessori intercambiabili / Replaceable accessories



28-04083-30
Piastra decorativa nera
Black front plate



28-04083-31
Piastra decorativa bianca
White front plate



28-04083-51
Piastra decorativa metal
Silver front plate



28-04083-67
Piastra decorativa ruggine
Rust front plate

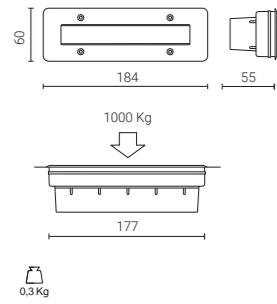

Codice Code	LED Lumen	Product Lumen	Watt	mA V _{dc}	Colour T (K)	CRI	T max (°C)
Controcassa in dotazione nell'apparecchio Recessed housing included in the fitting							
1583180	300 (3 LED)	-	3	350	3000 bianco / white	80	55°
1513180	100 (10 LED)	-	1,3	24	3500 bianco / white	80	40°
Driver da ordinare separatamente / Driver should be ordered separately							
81-04020	Output 350mA (15W) - max 4 apparecchi / max 4 fittings Corrente costante / Constant current distanza massima da driver 30 m / max distance from driver 30 m						
81-04006	Output 24V _{dc} (20W) - max 13 apparecchi / max 13 fittings Corrente costante / Constant current distanza massima da driver 30 m / max distance from driver 30 m						

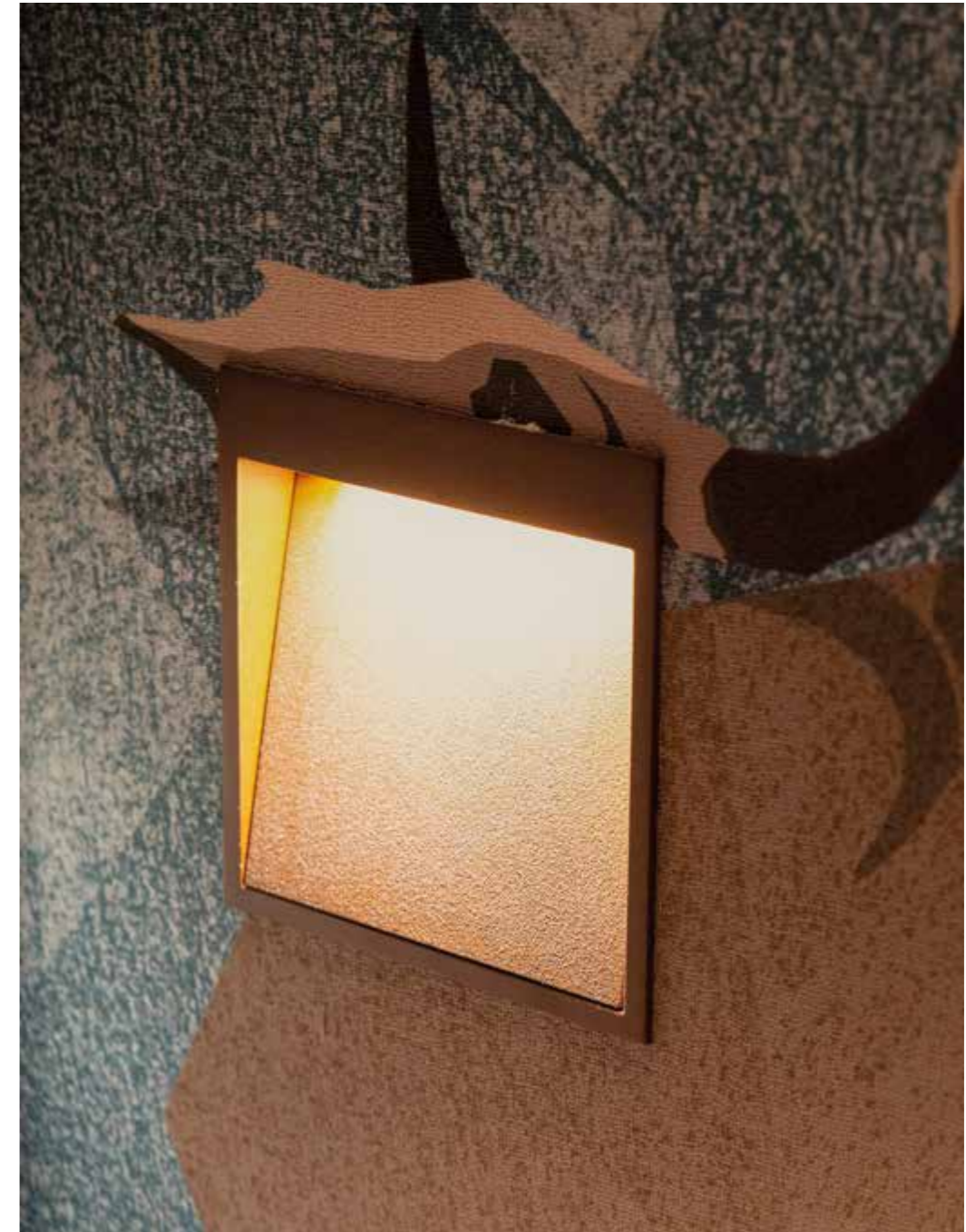

Wall-Cut 150
finitura ruggine / rust finish

Accessori/ Accessories



160821
Bobina di cavo di alimentazione
H05RN-F, 2x1mm², 10 mt
10 mt supply cable coil H05RN-F
2x1mm²



84108
Connettore stagno
Rated cable connector

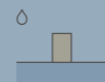

La scena si sposta all'esterno, luci puntate!

The scene moves outside, lights pointed!

^{ITA} Un'attenta ricerca in sviluppo e progettazione è a fondamento della creazione di questi proiettori. Una gamma che fa del minimalismo un elemento distintivo con la volontà di rendere i prodotti quasi impercettibili. Lo scopo è quello di limitare al massimo l'aspetto invasivo dell'apparecchio e focalizzarsi su ciò che è importante, ovvero gli elementi da valorizzare.

^{EN} Careful research in development and design is the basis of the creation of these projectors. A range that makes minimalism a peculiar detail for almost imperceptible fittings. The aim is to minimize the invasive part of the device and focus on what is salient, that is, the elements to be enhanced.





^{ITA} I proiettori Microperretto IP66 e Perretto IP66 possono essere accessoriati con snoot asimmetrico per direzionare il fascio luminoso e ridurre l'abbagliamento. Numerose le applicazioni: a parete, a soffitto, a pavimento oppure nel terreno.

^{EN} Microperretto IP66 and Perretto IP66 projectors can be equipped with an asymmetrical snoot to shield off the light beam and to reduce glare. They are suitable for many applications: wall, ceiling, or floor mounted.



^{ITA} Una nuova generazione di proiettori per esterno, dalla forma cilindrica essenziale e progettata per valorizzare ambienti di passaggio, porticati e terrazzi. Grazie al design minimale, dalle dimensioni miniaturizzate, contribuiscono alla resa estetica delle scelte d'arredo outdoor, in maniera discreta ed estremamente proporzionata. La semplicità di installazione e l'alta resistenza, favorita dallo speciale trattamento antiossidante e dalle guarnizioni siliciche, li rendono prodotti decisamente efficienti e versatili. La gamma di proiettori per esterni nasce per illuminare spazi all'aperto, ma design e performance accompagnano coerentemente il progetto anche negli spazi ibridi tra indoor e outdoor, suggerendo una continuità percettiva del confine permeabile tra l'interno e l'esterno.

^{EN} A new generation of outdoor projectors featuring an essential cylindrical shape specially designed to enhance passageways, porches, and terraces. Thanks to the minimal layout, with miniaturized dimensions, they contribute in a discreet and proportionate way to the aesthetics of the outdoor furniture. The easiness of installation and high resistance, thanks to the special antioxidant treatment and silicone gaskets, make them very efficient and versatile products. The range of outdoor projectors aims to illuminate outdoor spaces. Their consistent design and performance adapt the project even in hybrid spaces between interior and outdoor, suggesting a perceptive continuity of the permeable boundary between inside and outside.



^{ITA} Lito è caratterizzato da un design sobrio ed essenziale e fornisce un'elevata potenza di luce in abbinamento ad un ridotto impatto visivo. È in grado di creare scenografie luminose sia in spazi verdi sia su facciate. Dimensioni compatte e facilità di utilizzo li rendono ideali dove sia richiesta una luce d'accento ecologica anche in zone di passaggio.

^{EN} Lito features a sober and essential design and provides a high light output with a reduced visual impact. It can create luminous scenographies both in green spaces and on facades. Compact dimensions and ease of use make them ideal where ecological accent lighting is required, even in passageways.



^{ITA} Maxilito è un proiettore adatto a valorizzare spazi esterni di edifici privati e pubblici, giardini, facciate e vetrine. Il suo design accattivante ma discreto è ideale per applicazioni in contesti dove sia necessaria una luce d'effetto, potente, equilibrata ed ecologica.

Lito e Maxilito sono modelli di design depositato.
Design: Enrico Davide Bona e Elisa Nobile.

^{EN} Maxilito is a projector suitable for enhancing outdoor spaces of private and public buildings, gardens, façades, and shop windows. Its attractive but discreet design is ideal for applications where a powerful, balanced, and ecological effect light is required.

Lito and Maxilito are registered design models.
Design: Enrico Davide Bona and Elisa Nobile.



Versatile nelle sue applicazioni,
è ideale dove sia richiesta una luce
d'accento in esterni.

Versatile in its applications, it is ideal
where an exterior accent lighting is
required.

Products

Pages



Microperfetto IP66

242



Microperfetto IP66 Cupcake

244



Perfetto IP66

246



Lito with lens / Lito

248



Maxilito

249



Dino

250



Dedo 100

251

MICROPERFETTO IP66



Codice Code	Colore Colour	LED Lumen	Product Lumen	Watt	Colour T (K)	CRI	Fascio Beam
Driver integrato 230V - con lente in PMMA / 230V integrated driver - with PMMA lens							
1910C0030	Nero / Black	699	615	6	2700	80	21°
1910CW0030	Nero / Black	699	615	6	2700	80	38°
1910C0088	Rame spazzolato / Brushed copper	699	615	6	2700	80	21°
1910CW0088	Rame spazzolato / Brushed copper	699	615	6	2700	80	38°
19100030	Nero / Black	730	643	6	3000	80	21°
1910BW0030	Nero / Black	730	643	6	3000	80	38°
19100088	Rame spazzolato / Brushed copper	730	643	6	3000	80	21°
1910BW0088	Rame spazzolato / Brushed copper	730	643	6	3000	80	38°

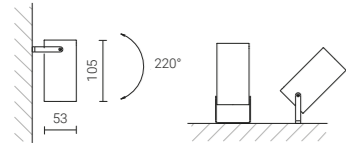

0,5 Kg

CE IP66 IK10

Codice Code	Colore Colour	LED Lumen	Product Lumen	Watt	Colour T (K)	CRI	Fascio Beam
Per trasformatore elettronico 48Vdc - con lente in PMMA / For 48Vdc electronic transformer - with PMMA lens							
1912C0030	Nero / Black	925	773	8,7	2700	80	21°
1912CW0030	Nero / Black	925	773	8,7	2700	80	38°
1912C0088	Rame spazzolato / Brushed copper	925	773	8,7	2700	80	21°
1912CW0088	Rame spazzolato / Brushed copper	925	773	8,7	2700	80	38°
19120030	Nero / Black	976	808	8,7	3000	80	21°
1912BW0030	Nero / Black	976	808	8,7	3000	80	38°
19120088	Rame spazzolato / Brushed copper	976	808	8,7	3000	80	21°
1912BW0088	Rame spazzolato / Brushed copper	976	808	8,7	3000	80	38°

Trasformatori elettronici 48Vdc per uso remoto da ordinare separatamente
48Vdc electronic transformers for remote use to be ordered separately

81-04054	Output 48Vdc 150W 220-240V Dimmerabile PWM / PWM dimmable
81-04055	Output 48Vdc 150W 220-240V On / Off

CE IP66 IK10

Accessori ottici intercambiabili / Replaceable optical accessories

Accessori su richiesta / Accessories on demand

28-4499-30
Frangilucente alveolare
Honeycomb

28-4445-30
Cilindro asimmetrico
Asymmetric snoot

28-2377-30
Picchetto in termoplastico nero
Black thermoplastic spike

MICROPERFETTO IP66



Codice Code	Colore Colour	LED Lumen	Product Lumen	Watt	mA	Colour T (K)	CRI	Fascio Beam
Sistema Dim to Warm - con lente in PMMA / Dim to Warm system - with PMMA lens								
1928MYN0030	Nero / Black	564*	508	6	350	1800-2700 Dim to Warm	90	19°
1928MWN0030	Nero / Black	564*	508	6	350	1800-2700 Dim to Warm	90	36°
1928MYN0088	Rame spazzolato / Brushed copper	564*	508	6	350	1800-2700 Dim to Warm	90	19°
1928MWN0088	Rame spazzolato / Brushed copper	564*	508	6	350	1800-2700 Dim to Warm	90	36°

* Valore riferito alla massima dimmerazione / Value referring to max dimming

Per driver DALI - con lente in PMMA / For DALI driver - with PMMA lens

1927CN0030	Nero / Black	511	450	4	350	2700	80	21°
		699	615	6	500	2700	80	21°
		925	773	8,7	700	2700	80	21°
1927CWN0030	Nero / Black	511	450	4	350	2700	80	38°
		699	615	6	500	2700	80	38°
		925	773	8,7	700	2700	80	38°
1927CN0088	Rame spazzolato / Brushed copper	511	450	4	350	2700	80	21°
		699	615	6	500	2700	80	21°
		925	773	8,7	700	2700	80	21°
1927CWN0088	Rame spazzolato / Brushed copper	511	450	4	350	2700	80	38°
		699	615	6	500	2700	80	38°
		925	773	8,7	700	2700	80	38°
1927BN0030	Nero / Black	534	470	4	350	3000	80	21°
		730	643	6	500	3000	80	21°
		967	808	8,7	700	3000	80	21°
1927BWN0030	Nero / Black	534	470	4	350	3000	80	38°
		730	643	6	500	3000	80	38°
		967	808	8,7	700	3000	80	38°
1927BN0088	Rame spazzolato / Brushed copper	534	470	4	350	3000	80	21°
		730	643	6	500	3000	80	21°
		967	808	8,7	700	3000	80	21°
1927BWN0088	Rame spazzolato / Brushed copper	534	470	4	350	3000	80	38°
		730	643	6	500	3000	80	38°
		967	808	8,7	700	3000	80	38°

Driver IP68 da ordinare separatamente / IP68 drivers should be ordered separately

81-04038	Output 350mA (anche per Dim to Warm / also for Dim to Warm) Dimmerabile DALI / DALI dimmable
81-02472	Output 350mA Regolabile sul taglio di fase / Dimmable on the mains
81-04039	Output 500mA - max 4 apparecchi / max 4 fittings Dimmerabile DALI / DALI dimmable
81-04034	Output 700mA - max 3 apparecchi / max 3 fittings Dimmerabile DALI / DALI dimmable

Driver IP68 da ordinare separatamente / IP68 drivers should be ordered separately

81-04007	Output 350mA (IP20) Regolabile sul taglio di fase e 1-10V Dimmable on the mains and 1-10V
----------	---

CE IP66 IK10

Accessori ottici intercambiabili / Replaceable optical accessories

Accessori su richiesta / Accessories on demand

28-4499-30
Frangilucente alveolare
Honeycomb

28-4445-30
Cilindro asimmetrico
Asymmetric snoot

28-2377-30
Picchetto in termoplastico nero
Black thermoplastic spike

MICROPERFETTO IP66 CUPCAKE



Codice Code	Colore Colour	LED Lumen	Product Lumen	Watt	Colour T (K)	CRI	Fascio Beam
Driver integrato 230V - con lente in PMMA / 230V integrated driver - with PMMA lens							
1915C0030	Nero / Black	699	615	6	2700	80	21°
1915CW0030	Nero / Black	699	615	6	2700	80	38°
1915C0021	Bianco mat / Mat white	699	615	6	2700	80	21°
1915CW0021	Bianco mat / Mat white	699	615	6	2700	80	38°
19150030	Nero / Black	730	643	6	3000	80	21°
1915BW0030	Nero / Black	730	643	6	3000	80	38°
19150021	Bianco mat / Mat white	730	643	6	3000	80	21°
1915BW0021	Bianco mat / Mat white	730	643	6	3000	80	38°

CE IP66 IK10

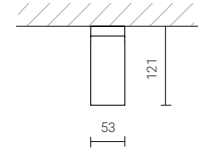

0,5 Kg

Codice Code	Colore Colour	LED Lumen	Product Lumen	Watt	Colour T (K)	CRI	Fascio Beam
Per trasformatore elettronico 48Vdc - con lente in PMMA / For 48Vdc electronic transformer - with PMMA lens							
1917C0030	Nero / Black	925	773	8,7	2700	80	21°
1917CW0030	Nero / Black	925	773	8,7	2700	80	38°
1917C0021	Bianco mat / Mat white	925	773	8,7	2700	80	21°
1917CW0021	Bianco mat / Mat white	925	773	8,7	2700	80	38°
19170030	Nero / Black	976	808	8,7	3000	80	21°
1917BW0030	Nero / Black	976	808	8,7	3000	80	38°
19170021	Bianco mat / Mat white	976	808	8,7	3000	80	21°
1917BW0021	Bianco mat / Mat white	976	808	8,7	3000	80	38°

Trasformatori elettronici 48Vdc per uso remoto da ordinare separatamente
48Vdc electronic transformers for remote use to be ordered separately

81-04054	Output 48Vdc 150W 220-240V Dimmerabile PWM / PWM dimmable
81-04055	Output 48Vdc 150W 220-240V On / Off

CE IP66 IK10

Accessori ottici intercambiabili / Replaceable optical accessories

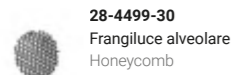

28-4499-30
Frangiluca alveolare
Honeycomb

Accessori su richiesta / Accessories on demand



84108
Connettore stagno
Rated cable connector

MICROPERFETTO IP66 CUPCAKE



Codice Code	Colore Colour	LED Lumen	Product Lumen	Watt	mA	Colour T (K)	CRI	Fascio Beam
Per driver DALI - con lente in PMMA / For DALI driver - with PMMA lens								
1929CN0030	Nero / Black	511	450	4	350	2700	80	21°
		699	615	6	500	2700	80	21°
		925	773	8,7	700	2700	80	21°
1929CWN0030	Nero / Black	511	450	4	350	2700	80	38°
		699	615	6	500	2700	80	38°
		925	773	8,7	700	2700	80	38°
1929CN0021	Bianco mat / Mat white	511	450	4	350	2700	80	21°
		699	615	6	500	2700	80	21°
		925	773	8,7	700	2700	80	21°
1929CWN0021	Bianco mat / Mat white	511	450	4	350	2700	80	38°
		699	615	6	500	2700	80	38°
		925	773	8,7	700	2700	80	38°
1929BN0030	Nero / Black	534	470	4	350	3000	80	21°
		730	643	6	500	3000	80	21°
		967	808	8,7	700	3000	80	21°
1929BWN0030	Nero / Black	534	470	4	350	3000	80	38°
		730	643	6	500	3000	80	38°
		967	808	8,7	700	3000	80	38°
1929BN0021	Bianco mat / Mat white	534	470	4	350	3000	80	21°
		730	643	6	500	3000	80	21°
		967	808	8,7	700	3000	80	21°
1929BWN0021	Bianco mat / Mat white	534	470	4	350	3000	80	38°
		730	643	6	500	3000	80	38°
		967	808	8,7	700	3000	80	38°

Driver IP68 da ordinare separatamente / IP68 drivers should be ordered separately

81-04038	Output 350mA - max 5 apparecchi / max 5 fittings Dimmerabile DALI / DALI dimmable
81-04039	Output 500mA - max 4 apparecchi / max 4 fittings Dimmerabile DALI / DALI dimmable
81-04034	Output 700mA - max 3 apparecchi / max 3 fittings Dimmerabile DALI / DALI dimmable

CE IP66 IK10

Accessori ottici intercambiabili / Replaceable optical accessories



28-4499-30
Frangiluca alveolare
Honeycomb

Accessori su richiesta / Accessories on demand



84108
Connettore stagno
Rated cable connector



Codice Code	Colore Colour	LED Lumen	Product Lumen	Watt	Colour T (K)	CRI	Fascio Beam
1035BZ0030	Nero / Black	2400	1778	18	3000	85	16°
10350030	Nero / Black	2400	1778	18	3000	85	26°
1035BV0030	Nero / Black	2400	1778	18	3000	85	45°
1035AZ0030	Nero / Black	2450	1816	18	4000	85	16°
1035A0030	Nero / Black	2450	1816	18	4000	85	26°
1035AV0030	Nero / Black	2450	1816	18	4000	85	45°
10370030	Nero / Black	3500	2594	30	3000	85	29°
1037BW0030	Nero / Black	3500	2594	30	3000	85	42°
1037A0030	Nero / Black	3590	2660	30	4000	85	29°
1037AW0030	Nero / Black	3590	2660	30	4000	85	42°

18W: Regolabile sulla fase / Dimmable on the mains
230/240V - 50/60Hz

CE IP66 IK10

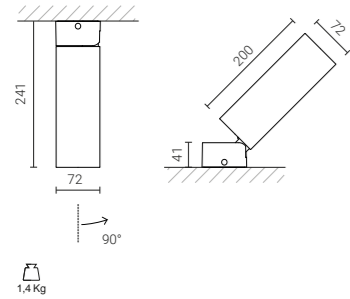

Perfetto IP66

Accessori ottici intercambiabili / Replaceable optical accessories

- 28-4163-30** (18W)
Frangiluce alveolare
Honeycomb
- 28-04191-47** (18W)
Vetro zigrinato
Prismatic spread lens
- 28-4208-30** (30W)
Frangiluce alveolare
Honeycomb
- 28-04190-47** (30W)
Vetro zigrinato
Prismatic spread lens
- 28-4130-30**
Cilindro asimmetrico
Asymmetric snoot

Accessori su richiesta / Accessories on demand

- 28-2377-30**
Picchetto in termoplastico nero
Black thermoplastic spike
- 84108**
Connettore stagno
Rated cable connector

LITO 230



Codice Code	Colore Colour	LED Lumen	Product Lumen	Watt	Colour T (K)	CRI	Fascio Beam
11430230	Nero / Black	1760	1567	12	3000	85	30°
11430285	Metal / Silver	1760	1567	12	3000	85	30°

220/240V - 50/60Hz

CE IP66 IK10

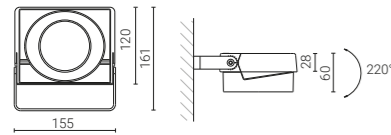

1,1 Kg

LITO



Codice Code	Colore Colour	LED Lumen	Product Lumen	Watt	Colour T (K)	CRI	Fascio Beam
11200030	Nero / Black	1800	1486	12	3000	85	30°
11200085	Metal / Silver	1800	1486	12	3000	85	30°

230/240V - 50/60Hz

CE IP66 IK10

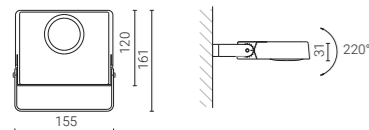

1,1 Kg

Accessori ottici intercambiabili solo per Lito 230 / Replaceable optical accessories only for Lito 230



28-3140-51
 Ottica professionale S (diffusore incluso)
 Professional optic device S (included diffuser)
 Fascio / Beam: 12°



28-3138-51
 Ottica professionale W
 Professional optic device W
 Fascio / Beam: 55°



28-3141-31
 Ottica professionale XW
 Professional optic device XW
 Fascio / Beam: 70°



28-4019-30
 Frangiluce alveolare
 Honeycomb

Accessori su richiesta / Accessories on demand



84108
 Connettore stagno
 Rated cable connector

MAXILITO

Proiettori per esterni Exterior projectors



Codice Code	Colore Colour	LED Lumen	Product Lumen	Watt	Colour T (K)	CRI	Fascio Beam
11461130	Nero / Black	6400	5775	51	3000	85	30°
11461185	Metal / Silver	6400	5775	51	3000	85	30°

230/240V - 50/60Hz

CE IP66 IK10

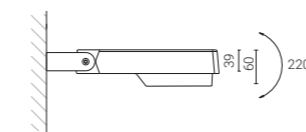
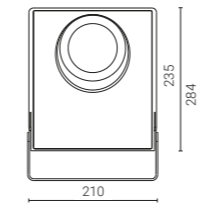

3,3 Kg

Accessori ottici intercambiabili / Replaceable optical accessories



28-3140-51
 Ottica professionale S (diffusore incluso)
 Professional optic device S (included diffuser)
 Fascio / Beam: 17°



28-3138-51
 Ottica professionale W
 Professional optic device W
 Fascio / Beam: 55°



28-3141-31
 Ottica professionale XW
 Professional optic device XW
 Fascio / Beam: 70°



28-4019-30
 Frangiluce alveolare
 Honeycomb

Accessori su richiesta / Accessories on demand



84108
 Connettore stagno
 Rated cable connector

DINO
CON LENTE / WITH LENS



Codice Code	Colore Colour	LED Lumen	Product Lumen	Watt	Colour T (K)	CRI	Fascio Beam
Con lente in PMMA / With PMMA lens							
173BZ0030	Nero / Black	534	-	4,1	3000	80	14°
173BZ0020	Grigio / Grey	534	-	4,1	3000	80	14°
173BW0030	Nero / Black	534	-	4,1	3000	80	36°
173BW0020	Grigio / Grey	534	-	4,1	3000	80	36°

230/240V - 50/60Hz

CE IP67/44 IK08

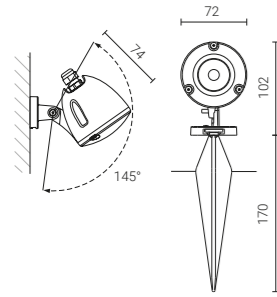

0,4 Kg

DEDO 100

Proiettori per esterni Exterior projectors



Codice Code	Colore Colour	LED Lumen	Product Lumen	Watt	Colour T (K)	CRI	Fascio Beam
111801	Nero / Black	1700	1428	12	3000	85	30°
111802	Grigio / Grey	1700	1428	12	3000	85	30°

220/240V - 50/60Hz

CE IP66 IK08

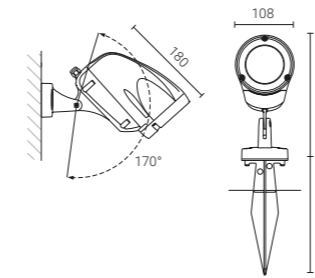

0,8 Kg

Accessori ottici intercambiabili / Replaceable optical accessories



28-3140-51
Ottica professionale S (diffusore incluso)
Professional optic device S (included diffuser)
Fascio / Beam: 11°



28-3138-51
Ottica professionale W
Professional optic device W
Fascio / Beam: 55°



28-3141-31
Ottica professionale XW
Professional optic device XW
Fascio / Beam: 70°

Accessori su richiesta / Accessories on demand



160821
Bobina di cavo di alimentazione
H05RN-F, 2x1mm², 10 mt
10mt supply cable coil H05RN-F
2x1mm²



84108
Connettore stagno
Rated cable connector

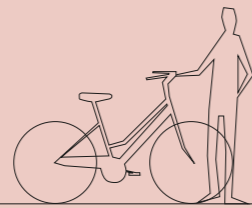

Protagonisti nella notte

Protagonists in the night

^{ITA} Linee sottili e geometrie compatte rendono questi prodotti diversi tra loro, ma coerenti con i contesti nei quali vengono inseriti. La sobrietà che li caratterizza si adatta perfettamente con la resa illuminotecnica delle elevate performance che sono in grado di garantire in qualsiasi spazio esterno.

^{EN} Thin lines and compact geometries make these products different from each other but consistent with the space. The sobriety that distinguishes them perfectly fits the high performance they can guarantee in any outdoor space.



Pole-Cut 80

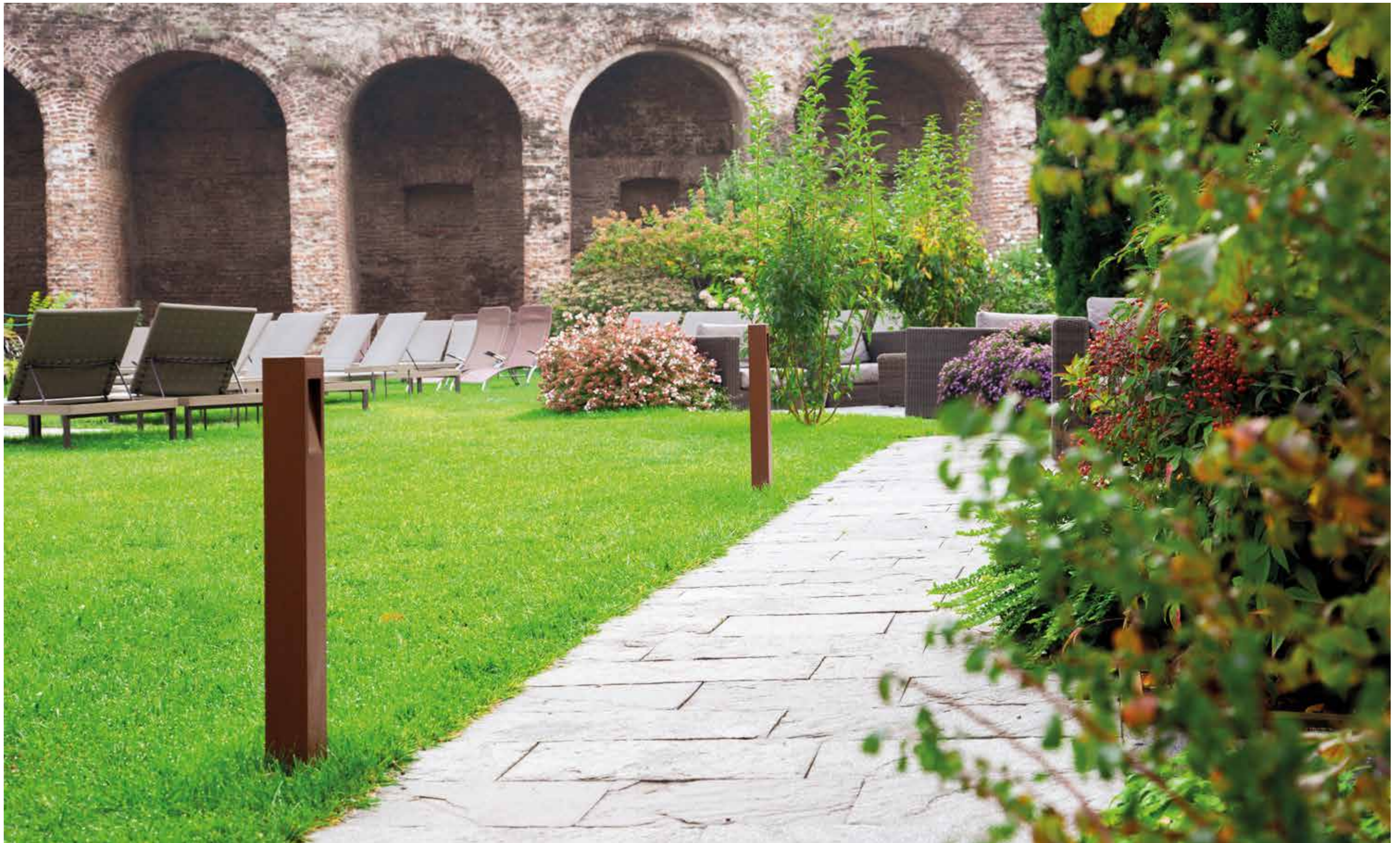

^{ITA} Pole-Cut è la nuova versione su palo di Wall-Cut, definito dalla sua rigorosa geometria e da finiture che lo rendono perfetto per applicazioni all'esterno. La luce, confortevole e morbida, valorizza percorsi e camminamenti. La coerenza di design fa sì che Pole-Cut e Wall-Cut possano essere abbinati in soluzioni progettuali prestigiose e ricercate.

^{EN} Pole-Cut is the new version on the pole of Wall-Cut recessed wall light, defined by its rigorous geometry and finishes that make it perfect for outdoor applications. The light, comfortable and soft, enhances paths and walkways. The coherence of design ensures that Pole-Cut and Wall-Cut can be combined for prestigious and refined design solutions.

QC Terme - Milano
Pole-Cut 80 ruggine / rust

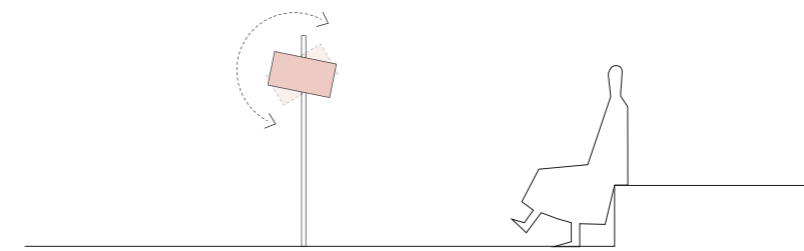

rotazione 220° | 220° tilting



In armonia con l'ambiente

In harmony with nature

^{ITA} Microperfetto IP66 Stelo è l'ultima novità della gamma di luci per esterno. Il design elegante lo rende adattabile e in perfetta armonia con qualsiasi contesto outdoor. Il prodotto è installabile in due differenti modalità: con picchetto, nel terreno, o direttamente a terra su base. Microperfetto IP66 Stelo è equipaggiato con LED COB di ultima generazione per un'elevata efficienza illuminotecnica.

^{EN} Microperfetto IP66 Stelo is the latest bollard in the range of outdoor luminaires. Its elegant and harmonious design enhances any exterior space. You can choose among different mounting options, with a spike for installation in the ground or with a steel base. Microperfetto IP66 Stelo features the latest generation of COB LEDs for high visual comfort.





Luci da appoggio
per esterni

Bollards



INDEX

Products

Pages



Microperfetto IP66 Stelo

261



Pole-Cut 80

262



Bidi Bollard

263



Microperretto IP66 Stelo

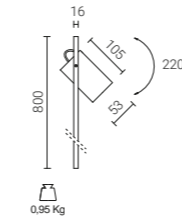

Codice Code	Colore Colour	LED Lumen	Product Lumen	Watt	Colour T (K)	CRI	Fascio Beam
Driver integrato 230V - con lente in PMMA 230V integrated driver - with PMMA lens							
1940C0030	Nero / Black	699	615	6	2700	80	21°
1940CW0030	Nero / Black	699	615	6	2700	80	38°
19400030	Nero / Black	730	643	6	3000	80	21°
1940BW0030	Nero / Black	730	643	6	3000	80	38°

CE IP66 IK10

Codice Code	Colore Colour	LED Lumen	Product Lumen	Watt	Colour T (K)	CRI	Fascio Beam
Per trasformatore elettronico 48Vdc - con lente in PMMA For 48Vdc electronic transformer - with PMMA lens							
1941C0030	Nero / Black	925	773	8,7	2700	80	21°
1941CW0030	Nero / Black	925	773	8,7	2700	80	38°
19410030	Nero / Black	967	808	8,7	3000	80	21°
1941BW0030	Nero / Black	967	808	8,7	3000	80	38°

Trasformatori elettronici 48Vdc per uso remoto da ordinare separatamente
48Vdc electronic transformers for remote use to be ordered separately

81-04054	48Vdc 150W 220/240V Dimmerabile PWM / PWM dimmable
81-04055	48Vdc 150W 220/240V On / Off

CE IP66 IK10

Accessori ottici intercambiabili / Replaceable optical accessories



28-4445-30
Cilindro asimmetrico
Asymmetric snoot



28-4499-30
Frangiluce alveolare
Honeycomb

Accessori obbligatori per l'installazione / Compulsory accessories for installation



28-04573-30
Picchetto in termoplastico nero
Black thermoplastic spike



28-04577-16
Base in acciaio verniciato nero
Base in black painted steel

POLE-CUT 80



Codice Code	LED Lumen	Product Lumen	Watt	Colour T (K)	CRI	Fascio Beam
Corpo interno (LED + driver + controscassa) Inner body (LED + driver + recessed housing)						
151147	500	225	4,5	3000	80	α 53° / β 91°
1511C47	500	225	4,5	2700	80	α 53° / β 91°

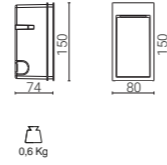

0,6 Kg

220/240V - 50/60Hz



Corpo esterno (cornice + piastra decorativa)
Outer body (frame + decorative plate)

Codice Code	Cornice Frame	Piastra Plate
28-04093-01	Nero / Black	+ Nero / Black
28-04093-67	Ruggine / Rust	+ Ruggine / Rust
28-04093-85	Metal / Silver	+ Metal / Silver
28-04093-100	Nero / Black	+ Oro satinato / Satin gold



Palo rettangolare (con base e tappo)
Rectangular pole (with base and cap)

Codice Code	Cornice Frame	Altezza Height
28-04497-01	Nero / Black	h. 300 mm
28-04497-67	Ruggine / Rust	h. 300 mm
28-04497-85	Metal / Silver	h. 300 mm
28-04370-01	Nero / Black	h. 700 mm
28-04370-67	Ruggine / Rust	h. 700 mm
28-04370-85	Metal / Silver	h. 700 mm

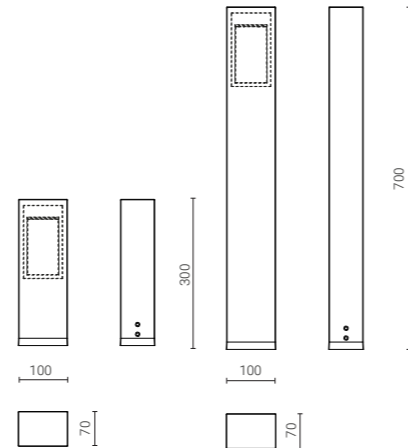

Accessori intercambiabili / Replaceable accessories



28-04094-30
Piastra decorativa nera
Black front plate



28-04094-31
Piastra decorativa bianca
White front plate



28-04094-51
Piastra decorativa metal
Silver front plate



28-04094-67
Piastra decorativa ruggine
Rust front plate



28-04094-100
Piastra decorativa oro satinato
Satin gold front plate

BIDI BOLLARD

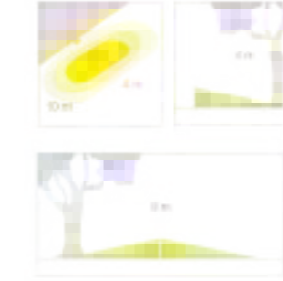

Codice Code	Colore Colour	LED Lumen	Product Lumen	Watt	Colour T (K)	CRI	Fascio Beam
Testa illuminante monodirezionale con ottica asimmetrica. Regolabile sulla fase Monodirectional lighting head with asymmetric optics. Dimmable on the mains							
190501	Nero / Black	1x1800	1x1271	1x12	3000	85	α 40° / β 85°
190567	Ruggine / Rust	1x1800	1x1271	1x12	3000	85	α 40° / β 85°
Testa illuminante bidirezionale con ottiche asimmetriche Monodirectional lighting head with asymmetric optics							
190601	Nero / Black	2x1800	2x1271	2x12	3000	85	α 40° / β 85°
190667	Ruggine / Rust	2x1800	2x1271	2x12	3000	85	α 40° / β 85°

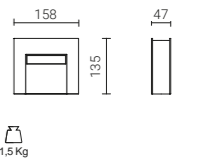

1,5 Kg

Le teste illuminanti devono essere ordinate separatamente
Lighting heads should be ordered separately

220/240V - 50/60Hz



Palo rettangolare (con base)
Rectangular pole (with base)

Codice Code	Cornice Frame	Altezza Height
1636801	Nero / Black	h 685 mm
1636867	Ruggine / Rust	h 685 mm

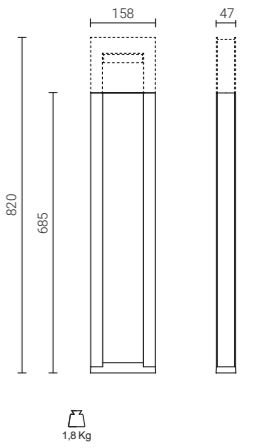

1,8 Kg

**Luci da facciata
per esterni**

**Exterior façade
lights**

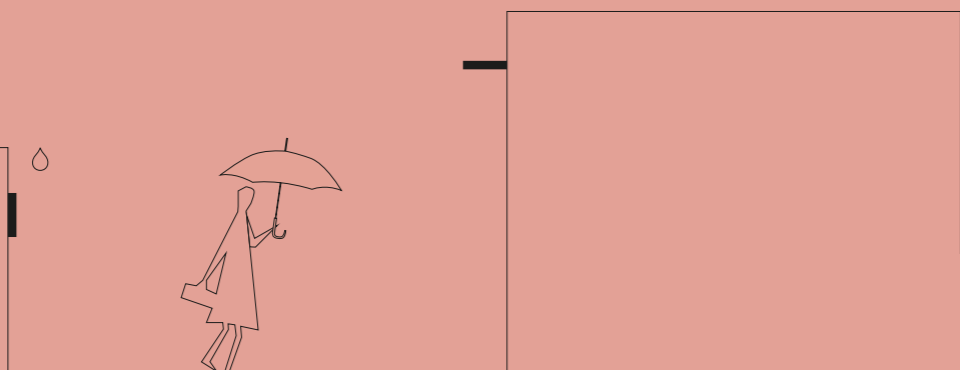

Esterno, notte. La luce scalda la scena

Outside, night. The light warms the scene

^{ITA} Apparecchi architettonici che permettono di realizzare disegni di luce sulle facciate degli edifici, esaltandone i ritmi e i particolari architettonici. Una gamma di prodotti completa caratterizzata da semplicità geometrica e tratti sinuosi che ben si adatta ad applicazioni anche in interni.

^{EN} Architectural lights allow the creation of light designs on the façades of buildings, enhancing the rhythms and architectural details. They are a complete range of products featuring geometric simplicity and sinuous lines that are well suited also for indoor applications.

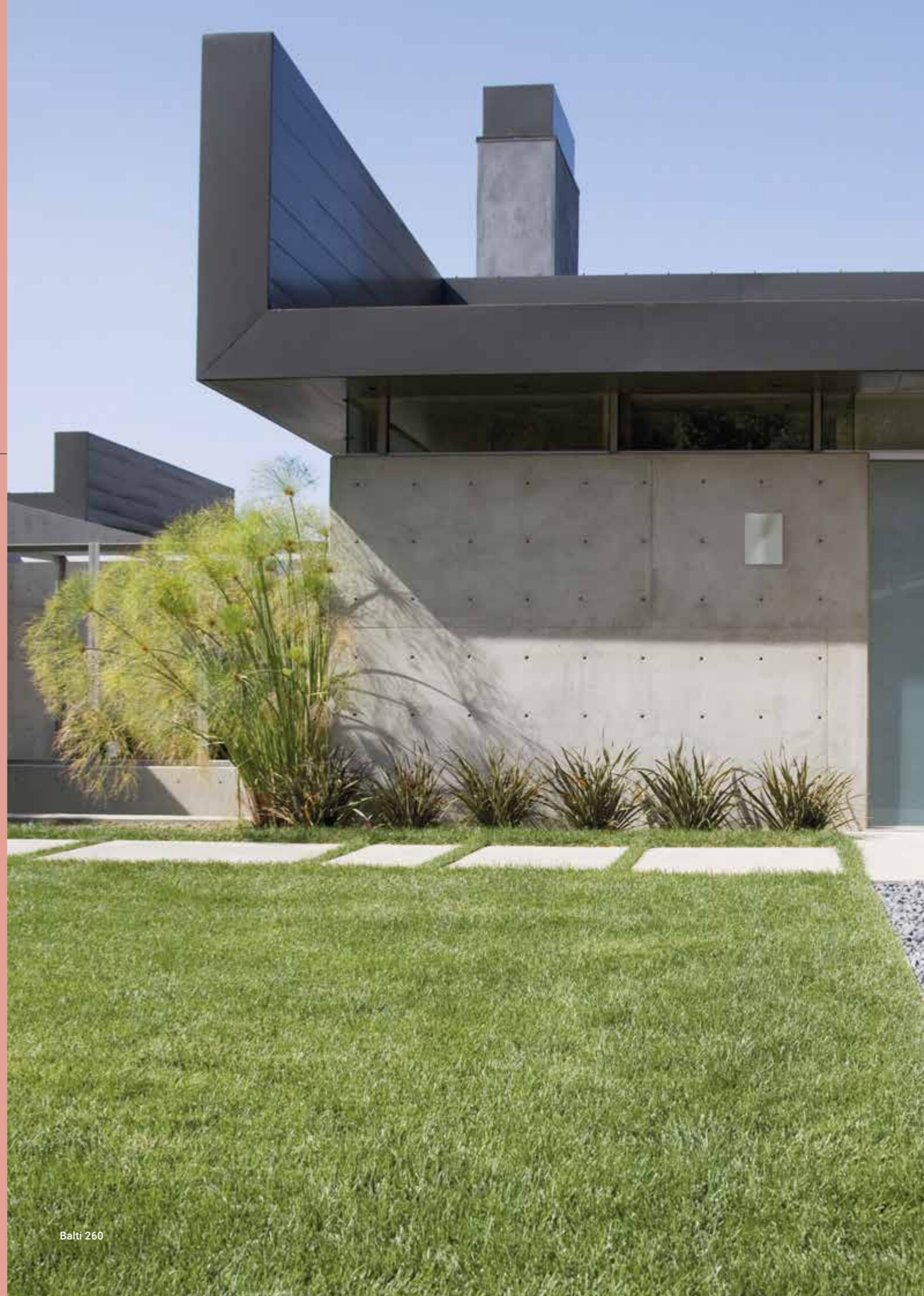



^{ITA} La gamma di luci da facciata Balti comprende quattro dimensioni che offrono svariate possibilità di illuminazione. La diffusione della luce è sottolineata da una leggera increspatura nel corpo del prodotto, che consente a Balti di collocarsi con eleganza anche in interni. Un profilo estremamente aderente alla parete, lo rende ideale per applicazioni in aree di passaggio, terrazze e come luce da facciata.

^{EN} The fittings of the range Balti are available in four dimensions, that offer a wide spectrum of lighting options. The light diffusion is underlined by a slight rippling in the body, allowing to install Balti with elegance also in indoor applications. The fittings reduce to a minimum the protrusion from the wall: they are ideal for applications in passageways, corridors, and terraces.

^{ITA} Il fascio luminoso di Balti è stato studiato con un'apertura specifica che permette di illuminare ampiamente la parete e, a seconda dell'applicazione, il soffitto o il pavimento senza abbagliare, grazie al particolare grado di inclinazione del LED all'interno dell'apparecchio.

Balti è modello di design depositato.
Design: Enrico Davide Bona e Elisa Nobile.

^{EN} Balti has been designed with a specific beam to ensure a wide lighting of the wall or of the ceiling and of the floor without glare, thanks to the specific angle of inclination of the LED within the fittings.

Balti is a registered design model.
Design: Enrico Davide Bona e Elisa Nobile.



Balti 260



Balti 80



^{ITA} Bidi Applique è un apparecchio dal design minimale e dalla figura parallelepipedica estremamente piatta, in grado di offrire elevate prestazioni luminose, ideale per l'illuminazione di facciate, superfici verticali o porticati. E' possibile scegliere tra la versione monodirezionale con ottica simmetrica oppure la versione bidirezionale con ottica asimmetrica e luce diffusa.

Bidi è modello di design depositato. Design: Enrico Davide Bona e Elisa Nobile.

^{EN} Bidi Applique is an innovative wall light with a minimal design and an extremely flat parallelepiped shape, able to stand out for the high-lighting performance. It is ideal to be mounted on façades, vertical surfaces, or arcades. It is possible to choose between the single light version with symmetric optic or the bidirectional one with asymmetric optic and diffused light.

Bidi is a registered design model. Design Enrico Davide Bona and Elisa Nobile.

Luci da facciata
per esterni

Exterior façade
lights



INDEX

Products

Pages



Balti 80 / Balti 150

270



Balti 220

271



Balti 260

272



Bidi Applique

273

BALTI 80



Codice Code	Colore Colour	LED Lumen	Product Lumen	Watt	Colour T (K)	CRI	Fascio Beam
Monodirezionale / Single-light							
119304	Bianco / White	850	646	6,5	3000	85	110°
119303	Metal / Silver	850	646	6,5	3000	85	110°

220/240V - 50/60Hz

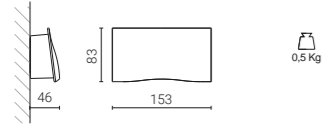

CE IP65 IK09

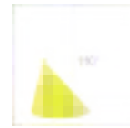

BALTI 150



Codice Code	Colore Colour	LED Lumen	Product Lumen	Watt	Colour T (K)	CRI	Fascio Beam
Monodirezionale / Single-light							
118504	Bianco / White	1800	1348	12	3000	85	110°
118503	Metal / Silver	1800	1348	12	3000	85	110°
118304	Bianco / White	3400	2551	26	3000	85	110°
118303	Metal / Silver	3400	2551	26	3000	85	110°

220/240V - 50/60Hz

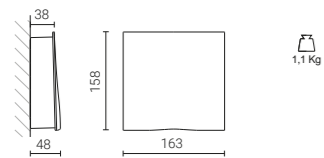

CE IP66 IK08

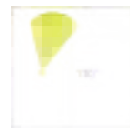

BALTI 220

Luci da facciata per esterni Exterior façade lights



Codice Code	Colore Colour	LED Lumen	Product Lumen	Watt	Colour T (K)	CRI	Fascio Beam
Bidirezionale / Bi-directional							
119804	Bianco / White	2x3400	2x2798	2x26	3000	85	110°/100°
119803	Metal / Silver	2x3400	2x2798	2x26	3000	85	110°/100°
Bidirezionale / Bi-directional							
119704	Bianco / White	2500+1200	2058+988	18+12,5	3000	85	44°/100°
119703	Metal / Silver	2500+1200	2058+988	18+12,5	3000	85	44°/100°
Monodirezionale / Single-light							
119604	Bianco / White	1x5200	1x4005	37	3000	85	100°
119603	Metal / Silver	1x5200	1x4005	37	3000	85	100°

220/240V - 50/60Hz

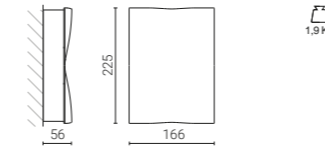

CE IP66 IK09



BALTI 260



Codice Code	Colore Colour	LED Lumen	Product Lumen	Watt	Colour T (K)	CRI	Fascio Beam
Bidirezionale / Bi-directional							
1081RW04	Bianco / White	2x2400	2x2040	2x18	3000	85	30°/30°
1081RW03	Metal / Silver	2x2400	2x2040	2x18	3000	85	30°/30°

220/240V - 50/60Hz

CE IP66 IK09

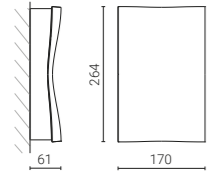

1,7 Kg



BIDI APPLIQUE



Codice Code	Colore Colour	LED Lumen	Product Lumen	Watt	Colour T (K)	CRI	Fascio Beam
Testa illuminante monodirezionale con ottica simmetrica. Regolabile sulla fase Monodirectional lighting head with symmetric optic. Dimmable on the mains							
190704	Bianco / White	1x1800	1x1350	1x12	3000	85	44°
190701	Nero / Black	1x1800	1x1350	1x12	3000	85	44°
190767	Ruggine / Rust	1x1800	1x1350	1x12	3000	85	44°
Testa illuminante bidirezionale con ottiche asimmetriche Bi-directional lighting head with asymmetric optics							
190604	Bianco / White	2x1800	2x1271	2x12	3000	85	α 40°/β 85°
190601	Nero / Black	2x1800	2x1271	2x12	3000	85	α 40°/β 85°
190667	Ruggine / Rust	2x1800	2x1271	2x12	3000	85	α 40°/β 85°

Le teste illuminanti devono essere ordinate separatamente dalla base per attacco a parete
Lighting heads should be ordered separately from the base for wall mounting

220/240V - 50/60Hz

CE IP66 IK10

Base per attacco a parete
Base for wall mounting

Codice Code	Colore Colour
1635004	Bianco / White
1635001	Nero / Black
1635067	Ruggine / Rust

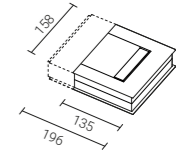
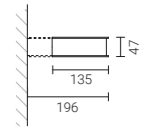

1,5 Kg

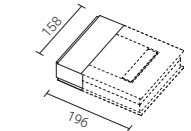
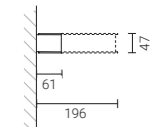

0,2 Kg

Accessori ottici intercambiabili / Replaceable optical accessories



28-3869-51
Ottica professionale M
Professional optic device M
Fascio / Beam: 30°/30°



28-3868-51
Ottica professionale W
Professional optic device W
Fascio / Beam: 50°/50°



28-3868-31
Ottica professionale XW
Professional optic device XW
Fascio / Beam: 65°/65°

Luci da plafone
per esterni

Exterior ceiling
lights

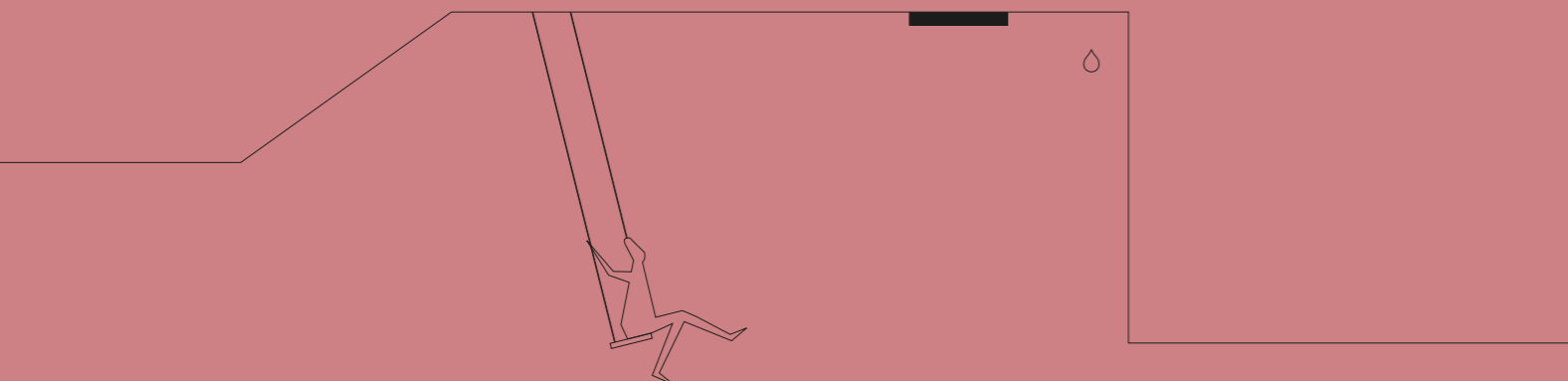
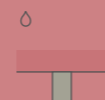

Cala il sipario, si accendono le luci

The curtain falls, the lights turn on

^{ITA} Linee geometriche essenziali, forme tonde, ma non per questo banali. Profili estremamente sottili, ma garbati ed eleganti. Prodotti che, all'interno di ambienti di vario genere si integrano senza fatica, con discrezione e sobrietà.

^{EN} Essential geometric lines, round and square shapes. Simple but not banal. They feature an extremely shallow but graceful and elegant profile. Fittings that easily integrate with discretion and sobriety into various spaces, also indoors.

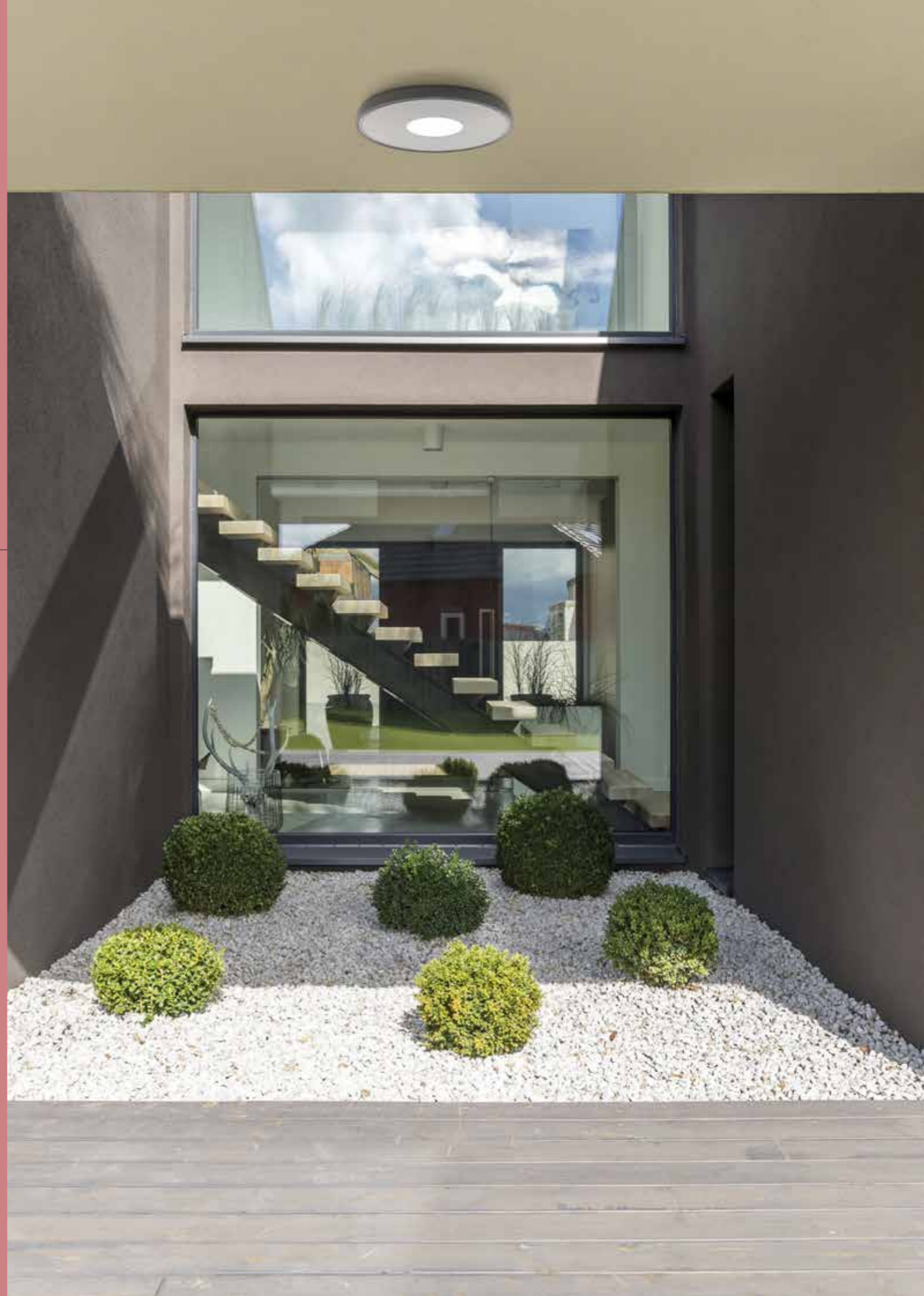

Luci da plafone
per esterni

Exterior ceiling
lights



ITA Le plafoniere per esterni PN sono state studiate appositamente per ospitare sorgenti LED COB di ultima generazione, in grado di garantire un'elevata qualità della luce, oltre ad un considerevole risparmio energetico. Applicabile a parete o a plafone, è ideale per risolvere molteplici esigenze di illuminazione anche in ambienti interni come atri, balconi, portici, aree residenziali e spazi a verde in generale.

EN PN outdoor ceiling lights have been specially designed to accommodate the latest generation COB LED sources that guarantee high quality of light and considerable energy savings. Applicable to the wall or ceiling, it is ideal for solving multiple lighting needs in spaces such as atriums, balconies, porches, residential areas, and green areas.



ITA Il design ha privilegiato forme geometriche essenziali ed uno spessore estremamente ridotto. Lo schermo frontale, elemento estetico oltre che protettivo, è senza viti a vista.

PN è modello di design depositato. Design: Enrico Davide Bona e Elisa Nobile.

EN The design has privileged geometric essential lines and an extremely small thickness. The front screen, having a decorative as well as a safety function, is screwless.

PN is a registered design model. Design: Enrico Davide Bona and Elisa Nobile.



Luci da plafone
per esterni

Exterior ceiling
lights



INDEX

Products

Pages



PN 180

280



PN 230

280



PN 210

281



PN 280

281

PN 180



Codice Code	Colore Colour	LED Lumen	Product Lumen	Watt	Colour T (K)	CRI	Fascio Beam
144504	Bianco / White	1700	1453	12	3000	85	110°
144501	Nero / Black	1700	1453	12	3000	85	110°
144503	Metal / Silver	1700	1453	12	3000	85	110°

220/240V - 50/60Hz

CE IP65 IK08

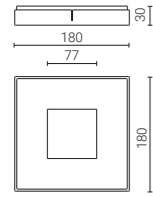

1,2 Kg

PN 230



Codice Code	Colore Colour	LED Lumen	Product Lumen	Watt	Colour T (K)	CRI	Fascio Beam
144004	Bianco / White	2400	2040	18	3000	85	110°
144001	Nero / Black	2400	2040	18	3000	85	110°

220/240V - 50/60Hz

CE IP65 IK08

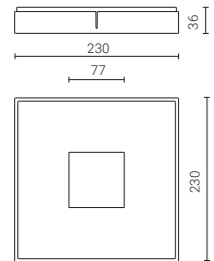

2,0 Kg

PN 210



Codice Code	Colore Colour	LED Lumen	Product Lumen	Watt	Colour T (K)	CRI	Fascio Beam
138004	Bianco / White	1800	1538	12	3000	85	120°
138001	Nero / Black	1800	1538	12	3000	85	120°
138003	Metal / Silver	1800	1538	12	3000	85	120°

230/240V - 50/60Hz

CE IP65 IK08

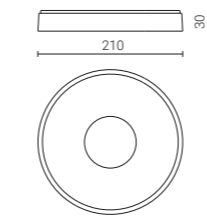

1,2 Kg

PN 280



Codice Code	Colore Colour	LED Lumen	Product Lumen	Watt	Colour T (K)	CRI	Fascio Beam
139004	Bianco / White	2400	2040	18	3000	85	120°
139001	Nero / Black	2400	2040	18	3000	85	120°
139003	Metal / Silver	2400	2040	18	3000	85	120°
139204	Bianco / White	3800	3230	30	3000	85	120°
139201	Nero / Black	3800	3230	30	3000	85	120°
139203	Metal / Silver	3800	3230	30	3000	85	120°

230/240V - 50/60Hz

CE IP65 IK08

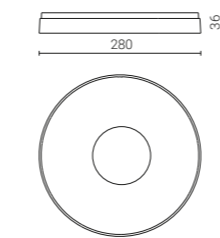

2,0 Kg

Cod	Name	Pag	Cod	Name	Pag
84108	Accessory	65,66	139203	PN 280	281
10350030	Perfetto IP66	246	139204	PN 280	281
1035A0030	Perfetto IP66	246	144001	PN 230	280
1035AV0030	Perfetto IP66	246	144004	PN 230	280
1035AZ0030	Perfetto IP66	246	144501	PN 180	280
1035BV0030	Perfetto IP66	246	144503	PN 180	280
1035BZ0030	Perfetto IP66	246	144504	PN 180	280
10370030	Perfetto IP66	246	1453100	Perfetto IN-Ground asymmetric	217
1037A0030	Perfetto IP66	246	1455000	Perfetto IN-Ground with lens	216
1037AW0030	Perfetto IP66	246	1455BV000	Perfetto IN-Ground with lens	216
1037BW0030	Perfetto IP66	246	1456000	Perfetto IN-Ground with lens	216
1081RW03	Balti 260	272	146200	Achille 320 LED	220
1081RW04	Balti 260	272	146300	Achille 320 LED	220
111801	Dedo 100	251	147000	Achille 450 LED	221
111802	Dedo 100	251	147900	Achille 320 LED	220
11200030	Lito	248	148000	Achille 320 LED	220
11200085	Lito	248	149401	Achille 190 LED	219
11430230	Lito 230	248	149501	Achille 190 LED	219
11430285	Lito 230	248	150747	Wall-Cut 150	231
11461130	Maxilito	249	150847	Wall-Cut 150	231
11461185	Maxilito	249	1508C47	Wall-Cut 150	231
118303	Balti 150	270	151147	Wall-Cut 80	230
118304	Balti 150	270	151147	Pole-Cut 80	262
118503	Balti 150	270	1511C47	Wall-Cut 80	230
118504	Balti 150	270	1511C47	Pole-Cut 80	262
119303	Balti 80	270	1513180	Stilled	232
119304	Balti 80	270	1528000	Nanoperfetto IN-Ground with lens	214
119603	Balti 220	271	1528010	Nanoperfetto IN-Ground with lens	214
119604	Balti 220	271	1528100	Nanoperfetto IN-Ground asymmetric	215
119703	Balti 220	271	1528BV000	Nanoperfetto IN-Ground with lens	214
119704	Balti 220	271	1528BV010	Nanoperfetto IN-Ground with lens	214
119803	Balti 220	271	1528C000	Nanoperfetto IN-Ground with lens	214
119804	Balti 220	271	1528C010	Nanoperfetto IN-Ground with lens	214
138001	PN 210	281	1528CV000	Nanoperfetto IN-Ground with lens	214
138003	PN 210	281	1528CV010	Nanoperfetto IN-Ground with lens	214
138004	PN 210	281	1543180	Nauto	218
139001	PN 280	281	1546480	Nauto	218
139003	PN 280	281	1557BW110	Nauto with lens	218
139004	PN 280	281	1557BZ110	Nauto with lens	218
139201	PN 280	281	1557BZ110	Nauto with lens	218

Cod	Name	Pag	Cod	Name	Pag
1557BZ210	Nauto with lens	218	19150021	Microperfetto IP66 Cupcake	244
1563180	Nauto	218	19150030	Microperfetto IP66 Cupcake	244
1583180	Stilled	232	1915B0021	Microperfetto IP66 Cupcake	244
160348	Accessory	220	1915B0030	Microperfetto IP66 Cupcake	244
160349	Accessory	221	1915C0021	Microperfetto IP66 Cupcake	244
160821	Accessory	216-219; 232; 251	1915C0030	Microperfetto IP66 Cupcake	244
160976	Accessory	189	1915CW0021	Microperfetto IP66 Cupcake	244
1635001	Accessory	273	1915CW0030	Microperfetto IP66 Cupcake	244
1635004	Accessory	273	19170021	Microperfetto IP66 Cupcake	244
1635067	Accessory	273	19170030	Microperfetto IP66 Cupcake	244
1636801	Accessory	263	1917B0021	Microperfetto IP66 Cupcake	244
1636867	Accessory	263	1917B0030	Microperfetto IP66 Cupcake	244
173BW0020	Dino with lens	250	1917C0021	Microperfetto IP66 Cupcake	244
173BW0030	Dino with lens	250	1917C0030	Microperfetto IP66 Cupcake	244
173BZ0020	Dino with lens	250	1917CW0021	Microperfetto IP66 Cupcake	244
173BZ0030	Dino with lens	250	1917CW0030	Microperfetto IP66 Cupcake	244
190501	Bidi Bollard	263	1927BN0030	Microperfetto IP66	243
190567	Bidi Bollard	263	1927BN0088	Microperfetto IP66	243
190601	Bidi Bollard / Bidi Applique	263; 273	1927BWN0030	Microperfetto IP66	243
190604	Bidi Applique	273	1927BWN0088	Microperfetto IP66	243
190667	Bidi Bollard / Bidi Applique	263; 273	1927CN0030	Microperfetto IP66	243
190701	Bidi Applique	273	1927CN0088	Microperfetto IP66	243
190704	Bidi Applique	273	1927CWN0030	Microperfetto IP66	243
190767	Bidi Applique	273	1927CWN0088	Microperfetto IP66	243
19100030	Microperfetto IP66	242	1928MWN0030	Microperfetto IP66	243
19100088	Microperfetto IP66	242	1928MWN0088	Microperfetto IP66	243
1910BW0030	Microperfetto IP66	242	1928MYN0030	Microperfetto IP66	243
1910BW0088	Microperfetto IP66	242	1928MYN0088	Microperfetto IP66	243
1910C0030	Microperfetto IP66	242	1929BWN0021	Microperfetto IP66 Cupcake	245
1910C0088	Microperfetto IP66	242	1929BWN0030	Microperfetto IP66 Cupcake	245
1910CW0030	Microperfetto IP66	242	1929BZN0021	Microperfetto IP66 Cupcake	245
1910CW0088	Microperfetto IP66	242	1929BZN0030	Microperfetto IP66 Cupcake	245
19120030	Microperfetto IP66	242	1929CWN0021	Microperfetto IP66 Cupcake	245
19120088	Microperfetto IP66	242	1929CWN0030	Microperfetto IP66 Cupcake	245
1912BW0030	Microperfetto IP66	242	1929CZN0021	Microperfetto IP66 Cupcake	245
1912BW0088	Microperfetto IP66	242	1929CZN0030	Microperfetto IP66 Cupcake	245
1912C0030	Microperfetto IP66	242	19400030	Microperfetto IP66 Stelo	261
1912C0088	Microperfetto IP66	242	1940B0030	Microperfetto IP66 Stelo	261
1912CW0030	Microperfetto IP66	242	1940C0030	Microperfetto IP66 Stelo	261
1912CW0088	Microperfetto IP66	242	1940CW0030	Microperfetto IP66 Stelo	261

Cod	Name	Pag	Cod	Name	Pag
19410030	Microperfetto IP66 Stelo	261	252-200	RA 4	68
1941BW0030	Microperfetto IP66 Stelo	261	254-219BN	Perfetto-IN 40 with lens	56
1941C0030	Microperfetto IP66 Stelo	261	254-219CN	Perfetto-IN 40 with lens	56
1941CW0030	Microperfetto IP66 Stelo	261	255-200AN	RA 11 Dixit LED	75
225-039BN	Perfetto-IN 50 with lens	57	255-200BN	RA 11 Dixit LED	75
225-039BRN	Perfetto-IN 50 with lens	57	256-200AN	RA 11 Dixit LED tilttable	79
225-039BWN	Perfetto-IN 50 with lens	57	256-200BN	RA 11 Dixit LED tilttable	79
225-039CN	Perfetto-IN 50 with lens	57	257-200BN	RA 11 TL Dixit LED	77
225-039CRN	Perfetto-IN 50 with lens	57	258-200BN	RA 11 Soft Dixit LED	78
225-039CWN	Perfetto-IN 50 with lens	57	259-200BN	RA 11 Q Dixit LED	76
225-129BVN	Perfetto-IN 50 IP65	57	260-049MN	Perfetto-IN 60 with lens	58
225-129CVN	Perfetto-IN 50 IP65	57	260-049MRN	Perfetto-IN 60 with lens	58
233-250BN	RA 8 Q Dixit LED	71	260-049MWN	Perfetto-IN 60 with lens	58
234-239BN	RA 8 L TL Dixit LED	72	260-069BN	Perfetto-IN 60 with lens	58
234-259BN	RA 8 TL Dixit LED	72	260-069BRN	Perfetto-IN 60 with lens	58
235-250B	RA 8 Dixit LED IP66 tilttable	74	260-069BWN	Perfetto-IN 60 with lens	58
237-239BN	RA 8 L Dixit LED IP65	70	260-069CN	Perfetto-IN 60 with lens	58
237-250AN	RA 8 Dixit LED IP65	70	260-069CRN	Perfetto-IN 60 with lens	58
237-250BN	RA 8 Dixit LED IP65	70	260-069CWN	Perfetto-IN 60 with lens	58
238-039BN	RA 8 Soft Dixit LED	73	261-069BN	Perfetto-IN 60 IP65/20 with lens	59
238-239AN	RA 8 L Dixit LED	69	261-069BRN	Perfetto-IN 60 IP65/20 with lens	59
238-239BN	RA 8 L Dixit LED	69	261-069BWN	Perfetto-IN 60 IP65/20 with lens	59
238-250AN	RA 8 Dixit LED	69	261-069CN	Perfetto-IN 60 IP65/20 with lens	59
238-250BN	RA 8 Dixit LED	69	261-069CRN	Perfetto-IN 60 IP65/20 with lens	59
239-250AN	RA 8 Dixit LED tilttable	74	261-069CWN	Perfetto-IN 60 IP65/20 with lens	59
239-250BN	RA 8 Dixit LED tilttable	74	262-019BNWW	Perfetto-IN 70 Wall Washer	61
243-250AN	RA 14 Dixit LED	81	262-019CNWW	Perfetto-IN 70 Wall Washer	61
243-250BN	RA 14 Dixit LED	81	262-039BN	Perfetto-IN 70	60
244-242AN	RA 20 Dixit LED	83	262-039BNW	Perfetto-IN 70	60
244-242BN	RA 20 Dixit LED	83	262-039BNY	Perfetto-IN 70	60
248-230BN	RA 17 Dixit LED	82	262-039CN	Perfetto-IN 70	60
249-240AN	RA 23 SP Dixit LED	83	262-039CNW	Perfetto-IN 70	60
249-240BN	RA 23 SP Dixit LED	83	262-039CNY	Perfetto-IN 70	60
249-250BN	RA 23 SP Dixit LED	83	262-049MN	Perfetto-IN 70	60
250-220AN	RA 16	82	263-039BN	Perfetto-IN 90	64
250-220BN	RA 16	82	263-039BNY	Perfetto-IN 90	64
250-230BN	RA 16	82	263-039CN	Perfetto-IN 90	64
251-200	RA 7	68	263-039CNY	Perfetto-IN 90	64
251-259BWN	RA 7 with lens	68	263-049MN	Perfetto-IN 90	64
251-259BZN	RA 7 with lens	68	265-250BNW	Perfetto-IN 90 IP66/20	66

Cod	Name	Pag	Cod	Name	Pag
265-250CNW	Perfetto-IN 90 IP66/20	66	274-019CZN	Minirooler-TL	54
266-069BN	Perfetto-IN 90 IP66 with lens	65	275-019BQN	Minirooler-TL	55
266-069BWN	Perfetto-IN 90 IP66 with lens	65	275-019BVN	Minirooler-TL	55
266-069CN	Perfetto-IN 90 IP66 with lens	65	275-019BYN	Minirooler-TL	55
266-069CWN	Perfetto-IN 90 IP66 with lens	65	275-019BZN	Minirooler-TL	55
268-039BN	Perfetto-IN 80	63	275-019CQN	Minirooler-TL	55
268-039BYN	Perfetto-IN 80	63	275-019CVN	Minirooler-TL	55
268-039CN	Perfetto-IN 80	63	275-019CYN	Minirooler-TL	55
268-039CYN	Perfetto-IN 80	63	275-019CZN	Minirooler-TL	55
268-069BN	Perfetto-IN 80 with lens	62	28-04082	Accessory	231
268-069BWN	Perfetto-IN 80 with lens	62	28-04083	Accessory	231
268-069CN	Perfetto-IN 80 with lens	62	28-04093	Accessory	230; 262
268-069CWN	Perfetto-IN 80 with lens	62	28-04094	Accessory	230; 262
269-039BN	Nanoperfetto UP	106	28-04190-47	Accessory	246
269-039BWN	Nanoperfetto UP	106	28-04191-47	Accessory	246
269-039CN	Nanoperfetto UP	106	28-04370	Accessory	262
269-039CWN	Nanoperfetto UP	106	28-04497	Accessory	262
272-019BQN	Minirooler-IN	52	28-04573-30	Accessory	261
272-019BVN	Minirooler-IN	52	28-04577-16	Accessory	261
272-019BYN	Minirooler-IN	52	28-2377-30	Accessory	242; 246
272-019BZN	Minirooler-IN	52	28-3138-51	Accessory	82; 186; 188; 220; 221; 248; 249; 251
272-019CQN	Minirooler-IN	52	28-3140-51	Accessory	75-79; 82; 186; 188; 220; 248; 249; 251
272-019CVN	Minirooler-IN	52	28-3141-31	Accessory	75-79; 82; 186; 188; 220; 221; 248; 249; 251
272-019CYN	Minirooler-IN	52	28-3142-51	Accessory	75-79; 186; 188; 220; 221
272-019CZN	Minirooler-IN	52	28-3868-31	Accessory	69; 70; 72; 74; 272
273-019BQN	Minirooler-IN	53	28-3868-51	Accessory	69; 70; 72; 74; 272
273-019BVN	Minirooler-IN	53	28-3869-51	Accessory	272
273-019BYN	Minirooler-IN	53	28-3901-51	Accessory	84; 85
273-019BZN	Minirooler-IN	53	28-3903-31	Accessory	71; 84; 85
273-019CQN	Minirooler-IN	53	28-3903-51	Accessory	71; 84; 85
273-019CVN	Minirooler-IN	53	28-3905-47	Accessory	63; 64; 84; 85; 143; 185
273-019CYN	Minirooler-IN	53	28-3957-30	Accessory	144; 145; 186; 188; 220; 221
273-019CZN	Minirooler-IN	53	28-3959-30	Accessory	144; 145; 186; 188; 220; 221
274-019BQN	Minirooler-TL	54	28-3979-100	Accessory	114; 142; 185
274-019BVN	Minirooler-TL	54	28-4019-30	Accessory	75-79; 248; 249
274-019BYN	Minirooler-TL	54	28-4039-100	Accessory	60
274-019BZN	Minirooler-TL	54	28-4039-31	Accessory	60
274-019CQN	Minirooler-TL	54	28-4065-103	Accessory	60
274-019CVN	Minirooler-TL	54	28-4065-47	Accessory	60
274-019CYN	Minirooler-TL	54	28-4065-61	Accessory	60

Cod	Name	Pag	Cod	Name	Pag
28-4073-103	Accessory	63; 64; 66; 110; 111; 132; 133; 138	3920-02C	Iconica	186
28-4073-61	Accessory	63; 64; 66; 110; 111; 133; 138	3922-02BN	Iconica	186
28-4074-47	Accessory	63; 64	3922-02CN	Iconica	186
28-4080-30	Accessory	143; 185	439-011	Zeppel 400	189
28-4105-100	Accessory	56	453-1603	Boma LED	146
28-4130-30	Accessory	246	453-2603	Boma LED	146
28-4139-100	Accessory	110; 111; 132; 133	457-230059B	35 Trentacinq - master linear element	30
28-4139-31	Accessory	110; 132; 133	457-230059C	35 Trentacinq - master linear element	30
28-4163-30	Accessory	62-66; 110; 111; 132; 133; 138; 246	457-230109B	35 Trentacinq - master linear element	30
28-4175-100	Accessory	184	457-230109C	35 Trentacinq - master linear element	30
28-4177-47	Accessory	216	457-230209B	35 Trentacinq - master linear element	30
28-4177-4730	Accessory	216	457-230209C	35 Trentacinq - master linear element	30
28-4181-21	Accessory	64; 65	457-230309B	35 Trentacinq - master linear element	30
28-4190-47	Accessory	66	457-230309C	35 Trentacinq - master linear element	30
28-4195-30	Accessory	216; 217	458-00010	35 Trentacinq - continuous linear element off	33
28-4197-48	Accessory	216; 217	458-00020	35 Trentacinq - continuous linear element off	33
28-4200-30	Accessory	184; 216	458-230059B	35 Trentacinq - continuous linear element	31
28-4208-30	Accessory	60; 246	458-230059C	35 Trentacinq - continuous linear element	31
28-4285-00	Accessory	230	458-230109B	35 Trentacinq - continuous linear element	31
28-4318-21	Accessory	64; 65	458-230109C	35 Trentacinq - continuous linear element	31
28-4327-30	Accessory	214	458-230209B	35 Trentacinq - continuous linear element	31
28-4445-30	Accessory	242; 261	458-230209C	35 Trentacinq - continuous linear element	31
28-4449-47	Accessory	58; 59	458-230309B	35 Trentacinq - continuous linear element	31
28-4499-30	Accessory	57-59; 106; 108; 109; 216; 242; 244; 245; 261	458-230309C	35 Trentacinq - continuous linear element	31
28-4499-47	Accessory	216	46-01	Accessory	33
28-4534-47	Accessory	140	46-02	Accessory	33
28-4535-30	Accessory	140	46-05-00	Accessory	33
28-4536-30	Accessory	84; 85; 114; 142; 185	46-09	Accessory	33; 34
28-4567-00	Accessory	214; 215	46-11	Accessory	33
28-9001-51	Accessory	219	46-12	Accessory	33
28-9003-51	Accessory	219	46-13	Accessory	33
28-9004-30	Accessory	143; 185	46-15	Accessory	33
3748-01	AP Line	173	46-17	Accessory	33; 34
3825-01	PF 15	174	470-01906	Linea 48vdc	137
3830-01	PF 22	174	470-02909	Linea 48vdc	137
3881-01	PF 19	175	470-03919	Linea 48vdc	137
3888-02	PF 30	175	470-07906	Linea 48vdc	137
3915-01	Floot	188	470-08909	Linea 48vdc	137
3916-01	Floot	188	471-019BQ	Minirooler 48Vdc	136
3920-02	Iconica	186	471-019BR	Minirooler 48Vdc	136

Cod	Name	Pag	Cod	Name	Pag
471-019BW	Minirooler 48Vdc	136	6447-20	35 Track	34
471-019BY	Minirooler 48Vdc	136	6447-30	35 Track	34
471-019BZ	Minirooler 48Vdc	136	6451-10	Accessory	160
471-019CQ	Minirooler 48Vdc	136	6451-11	Accessory	160
471-019CR	Minirooler 48Vdc	136	6452-00	Accessory	160
471-019CW	Minirooler 48Vdc	136	6453-00	Accessory	160; 161
471-019CY	Minirooler 48Vdc	136	6454-10	Accessory	160; 161
471-019CZ	Minirooler 48Vdc	136	6455-10	Accessory	160
472-019BQ	Minirooler 48Vdc	136	6455-11	Accessory	160
472-019BR	Minirooler 48Vdc	136	6456-00	Accessory	160
472-019BV	Minirooler 48Vdc	136	6457-00-00	Accessory	161
472-019BY	Minirooler 48Vdc	136	6458-00	Accessory	160
472-019BZ	Minirooler 48Vdc	136	6458-06	Accessory	160
472-019CQ	Minirooler 48Vdc	136	6459-20	Accessory	160
472-019CR	Minirooler 48Vdc	136	6460-00	Accessory	160
472-019CV	Minirooler 48Vdc	136	6461-00	Accessory	160; 161
472-019CY	Minirooler 48Vdc	136	6463-00-00	Accessory	160
472-019CZ	Minirooler 48Vdc	136	6464-10	Accessory	160
477-13005EE	35 Trentacinq - master RGBW	30	6464-11	Accessory	160
477-13010EE	35 Trentacinq - master RGBW	30	6465-03-31	Driver	35; 160; 161
477-13020EE	35 Trentacinq - master RGBW	30	6480-10	Accessory	161
477-13030EE	35 Trentacinq - master RGBW	30	6480-11	Accessory	161
478-13005EE	35 Trentacinq - continuous RGBW	31	6481-00	Accessory	161
478-13010EE	35 Trentacinq - continuous RGBW	31	6483-00	Accessory	161
478-13020EE	35 Trentacinq - continuous RGBW	31	6484-10	Accessory	161
478-13030EE	35 Trentacinq - continuous RGBW	31	6484-11	Accessory	161
508-211AN	Kardan-IN	84	6490-10	Accessory	34
508-211BN	Kardan-IN	84	6490-11	Accessory	34
508-221AN	Kardan-IN	84	6491-00	Accessory	34
508-221BN	Kardan-IN	84	6492-00	Accessory	34
509-211AN	Kardan-TL	85	6493-10	Accessory	34
509-211BN	Kardan-TL	85	6494-10	Accessory	34
509-221AN	Kardan-TL	85	6494-11	Accessory	34
509-221BN	Kardan-TL	85	6495-00	Accessory	34
6445-10	48Vdc Quadro _ Square	160	6496-00	Accessory	34
6445-20	48Vdc Quadro _ Square	160	6497-00	Accessory	34
6445-30	48Vdc Quadro _ Square	160	6498-00	Accessory	34
6446-10	48Vdc Incasso TL _ TL Recessed	161	6499-00	Accessory	34
6446-20	48Vdc Incasso TL _ TL Recessed	161	6500-00	Accessory	34
6446-30	48Vdc Incasso TL _ TL Recessed	161	6501-00	Accessory	34

Cod	Name	Pag	Cod	Name	Pag
743-2693	Perfetto Box	144	751-261BWDD	Perfetto Compact	143
743-4613	Perfetto Box	144	751-261BYDD	Perfetto Compact	143
747-469	Perfetto Box	144	751-3613	Perfetto Compact	143
748-119	Miniperfetto-S	185	751-3613BW	Perfetto Compact	143
748-119BV	Miniperfetto-S	185	751-3613BY	Perfetto Compact	143
748-129	Miniperfetto Base	114	7520-10	DKM Quadro _ Square	162
748-129BV	Miniperfetto Base	114	7520-20	DKM Quadro _ Square	162
748-129C	Miniperfetto Base	114	7520-30	DKM Quadro _ Square	162
748-129CV	Miniperfetto Base	114	7520-40	DKM Quadro _ Square	162
748-1592	Miniperfetto MM	142	752-1089M	Nanoperfetto 48Vdc with lens	130
748-1592A	Miniperfetto MM	142	752-1089MW	Nanoperfetto 48Vdc with lens	130
748-1693	Miniperfetto LKM	142	7521-20	DKM Incasso _ Recessed	163
748-219	Miniperfetto-S	185	7521-30	DKM Incasso _ Recessed	163
748-219BV	Miniperfetto-S	185	752-219BVN	Nanoperfetto-S	184
748-219C	Miniperfetto-S	185	752-219CVN	Nanoperfetto-S	184
748-219CV	Miniperfetto-S	185	752-729BWN0	Nanoperfetto Base	109
748-2592	Miniperfetto MM	142	752-729BYN0	Nanoperfetto Base	109
748-2693	Miniperfetto LKM	142	752-729CWNO	Nanoperfetto Base	109
748-2693C	Miniperfetto LKM	142	752-729CYN0	Nanoperfetto Base	109
7501-10	LKM Tondo _ Round	164	752-729MWN0	Nanoperfetto Base	109
7501-20	LKM Tondo _ Round	164	752-729MYN0	Nanoperfetto Base	109
7501-30	LKM Tondo _ Round	164	752-789	Nanoperfetto 48Vdc with lens	130
7511-10	LKM Quadro_Square	165	752-789BW	Nanoperfetto 48Vdc with lens	130
7511-20	LKM Quadro_Square	165	752-789C	Nanoperfetto 48Vdc with lens	130
7511-30	LKM Quadro_Square	165	752-789CW	Nanoperfetto 48Vdc with lens	130
7511-40	LKM Quadro_Square	165	752-889	Nanoperfetto 48Vdc with lens	130
751-1613BWMD	Perfetto Compact	143	752-889BW	Nanoperfetto 48Vdc with lens	130
751-1613BYMD	Perfetto Compact	143	752-889C	Nanoperfetto 48Vdc with lens	130
751-1613MD	Perfetto Compact	143	752-889CW	Nanoperfetto 48Vdc with lens	130
7512-10	LKM Incasso_Recessed	166	753-689	Microperfetto Low 48Vdc	132
751-211	Perfetto Compact-S	185	753-689BZ	Microperfetto Low 48Vdc	132
751-211BW	Perfetto Compact-S	185	753-689C	Microperfetto Low 48Vdc	132
7512-20	LKM Incasso_Recessed	166	753-689CZ	Microperfetto Low 48Vdc	132
751-221	Perfetto Compact	143	753-789	Microperfetto Low 48Vdc	132
7512-30	LKM Incasso_Recessed	166	753-789BZ	Microperfetto Low 48Vdc	132
7512-40	LKM Incasso_Recessed	166	753-789C	Microperfetto Low 48Vdc	132
751-261DD	Perfetto Compact	143	753-789CZ	Microperfetto Low 48Vdc	132
751-2613	Perfetto Compact	143	754-689	Microperfetto 48Vdc	133
751-2613BW	Perfetto Compact	143	754-789	Microperfetto 48Vdc	133
751-2613BY	Perfetto Compact	143	754-789BV	Microperfetto 48Vdc	133

Cod	Name	Pag	Cod	Name	Pag
754-789C	Microperfetto 48Vdc	133	7606-00	Accessory	162; 164-166
754-789CV	Microperfetto 48Vdc	133	7606-04-00	Accessory	162; 164; 165
754-889	Microperfetto 48Vdc	133	7606-05	Accessory	162; 164; 165
754-889BV	Microperfetto 48Vdc	133	7606-06	Accessory	162; 164; 165; 166
754-889C	Microperfetto 48Vdc	133	7607-00-00	Accessory	162-166
754-889CV	Microperfetto 48Vdc	133	7609-00-00	Accessory	162-166
755-679MN	Nanoperfetto-R with lens	108	7610-10-W	Accessory	164
755-679MRN	Nanoperfetto-R with lens	108	7618-00	Accessory	162-166; 188; 189
755-679MWN	Nanoperfetto-R with lens	108	762-049MVN	Microperfetto Cupcake	111
7557-00	Accessory	164-166	7621-10-W	Accessory	164
755-779BN	Nanoperfetto-R with lens	108	7621-11-W	Accessory	164
755-779BRN	Nanoperfetto-R with lens	108	7622-10-W	Accessory	164
755-779BWN	Nanoperfetto-R with lens	108	7623-00-W	Accessory	164
755-779CN	Nanoperfetto-R with lens	108	7624-00	Accessory	162-166
755-779CRN	Nanoperfetto-R with lens	108	7625-00	Accessory	162-166
755-779CWN	Nanoperfetto-R with lens	108	7626-00-00	Accessory	162; 164; 165
7558-00	Accessory	164-166; 188; 189	7651-10-W	Accessory	94; 162
7559-00	Accessory	162-163	7651-11-W	Accessory	94; 162
756-049MN	Microperfetto Low-R	110	7652-10-W	Accessory	94; 165
756-679BN	Microperfetto Low-R	110	7652-11-W	Accessory	94; 165
756-679BZN	Microperfetto Low-R	110	7653-10-W	Accessory	165
756-679CN	Microperfetto Low-R	110	7654-10-W	Accessory	162; 163; 165; 166
756-679CZN	Microperfetto Low-R	110	7655-10-W	Accessory	162; 165
758-679BVN	Microperfetto Cupcake	111	7655-11-W	Accessory	162; 165
758-679CVN	Microperfetto Cupcake	111	7656-10-W	Accessory	162; 165
7600-00	Accessory	164-166	7656-11-W	Accessory	162; 165
760-169A	Microperfetto LKM	138	7657-10-W	Accessory	162; 165
760-169AV	Microperfetto LKM	138	7658-10-W	Accessory	94; 162; 165
760-169B	Microperfetto LKM	138	7659-00-W	Accessory	94; 162; 165
760-169BV	Microperfetto LKM	138	76591-00-W	Accessory	163; 166
760-169C	Microperfetto LKM	138	7660-00-W	Accessory	162; 165
760-169CV	Microperfetto LKM	138	7661-10-W	Accessory	162
7602-10-W	Accessory	164	7662-10-W	Accessory	166
7602-11-W	Accessory	164	7662-11-W	Accessory	166
7603-10-W	Accessory	164	7663-10-W	Accessory	166
7604-10-W	Accessory	163; 166	7664-00-48	Accessory	163; 166
7604Q-10-W	Accessory	162; 165	7665-10-W	Accessory	163
7604T-10-W	Accessory	164	7665-11-W	Accessory	163
7605-10-W	Accessory	164	7666-10-W	Accessory	163
7605-11-W	Accessory	164	770-061	Perfetto Puro	145

Cod	Name	Pag	Cod	Name	Pag
770-061A	Perfetto Puro	145	7800-00	Accessory	167
770-061AT	Perfetto Puro	145	7802-00-W	Accessory	167
770-061AV	Perfetto Puro	145	780-269B	Microperfetto Large LKM	140
770-061AZ	Perfetto Puro	145	780-269BW	Microperfetto Large LKM	140
770-061BT	Perfetto Puro	145	780-269BY	Microperfetto Large LKM	140
770-061BV	Perfetto Puro	145	780-269C	Microperfetto Large LKM	140
770-061BZ	Perfetto Puro	145	780-269CW	Microperfetto Large LKM	140
770-069	Perfetto Puro	145	780-269CY	Microperfetto Large LKM	140
770-069BT	Perfetto Puro	145	7803-00-W	Accessory	167
770-069BV	Perfetto Puro	145	780-369B	Microperfetto Large LKM	140
770-069BZ	Perfetto Puro	145	780-369BW	Microperfetto Large LKM	140
7701-10	MM	167	780-369BY	Microperfetto Large LKM	140
7701-20	MM	167	780-369C	Microperfetto Large LKM	140
7701-30	MM	167	780-369CW	Microperfetto Large LKM	140
770-261	Perfetto Puro	145	780-369CY	Microperfetto Large LKM	140
770-261A	Perfetto Puro	145	7804-00-W	Accessory	167
770-261AT	Perfetto Puro	145	7805-00-W	Accessory	167
770-261AV	Perfetto Puro	145	7806-00	Accessory	167
770-261AZ	Perfetto Puro	145	7807-02-W	Accessory	167
770-261BT	Perfetto Puro	145	7810-00-W	Accessory	167
770-261BV	Perfetto Puro	145	781-169B	Microperfetto Large LKM zoom	141
770-261BZ	Perfetto Puro	145	781-169C	Microperfetto Large LKM zoom	141
770-269	Perfetto Puro	145	782-169B	Microperfetto Large LKM with lens	139
770-269BT	Perfetto Puro	145	782-169C	Microperfetto Large LKM with lens	139
770-269BV	Perfetto Puro	145	782-269B	Microperfetto Large LKM with lens	139
770-269BZ	Perfetto Puro	145	782-269C	Microperfetto Large LKM with lens	139
771-069	Perfetto Puro	145	7823-00-W	Accessory	167
771-069BT	Perfetto Puro	145	783-269B	Microperfetto Large LKM	140
771-069BV	Perfetto Puro	145	783-269BW	Microperfetto Large LKM	140
771-069BZ	Perfetto Puro	145	783-269BY	Microperfetto Large LKM	140
771-269	Perfetto Puro	145	783-269C	Microperfetto Large LKM	140
771-269BT	Perfetto Puro	145	783-269CW	Microperfetto Large LKM	140
771-269BV	Perfetto Puro	145	783-269CY	Microperfetto Large LKM	140
771-269BZ	Perfetto Puro	145	7841-13	Broadway	94
778-169B	Microperfetto Large LKM zoom	141	7841-13D	Broadway	94
778-169C	Microperfetto Large LKM zoom	141	7841-23	Broadway	94
779-169B	Microperfetto Large LKM with lens	139	7841-23D	Broadway	94
779-169C	Microperfetto Large LKM with lens	139	784-129BN	Microperfetto Large Base zoom	113
779-269B	Microperfetto Large LKM with lens	139	784-129CN	Microperfetto Large Base zoom	113
779-269C	Microperfetto Large LKM with lens	139	784-179BN	Microperfetto Large-R zoom	112

Cod	Name	Pag	Cod	Name	Pag
784-179CN	Microperfetto Large-R zoom	112	81-04008	Driver	68-70; 72
7842-13	Broadway	94	81-04009	Driver	60; 61; 63; 64; 66; 69-74; 110
7842-23	Broadway	94	81-04010	Driver	60; 63; 64; 66; 69-79; 84; 85; 110; 111
7850-00	Broadway	95	81-04011	Driver	63; 64; 75-79; 82; 84; 85; 110; 112; 113
7850E-00	Broadway	95	81-04012	Driver	75-79; 81; 82; 84; 85; 186
7850I-00	Broadway	95	81-04013	Driver	68; 81
7851-00-00	Broadway	95	81-04014	Driver	81
785-279BYN	Microperfetto Large-R with lens	112	81-04015	Driver	81; 82
785-279BZN	Microperfetto Large-R with lens	112	81-04016	Driver	83
785-279CYN	Microperfetto Large-R with lens	112	81-04018	Driver	83
785-279CZN	Microperfetto Large-R with lens	112	81-04019	Driver	56; 68
787-069B	Microperfetto Large Broadway zoom	97	81-04020	Driver	111; 216; 218; 232
787-069C	Microperfetto Large Broadway zoom	97	81-04021	Driver	84; 85
787-369BDD	Microperfetto Large Broadway zoom	97	81-04023	Driver	60; 61; 63; 64; 66
787-369CDD	Microperfetto Large Broadway zoom	97	81-04026	Driver	57-59; 65; 108; 108; 111
788-369B	Microperfetto Large Broadway with lens	96	81-04027	Driver	57; 62; 65; 184
788-369BDD	Microperfetto Large Broadway with lens	96	81-04028	Driver	57; 62; 65; 184
788-369C	Microperfetto Large Broadway with lens	96	81-04029	Driver	52; 54; 57; 58; 59; 62; 65; 108; 109; 184
788-369CDD	Microperfetto Large Broadway with lens	96	81-04031	Driver	68
794-189B	Microperfetto Large 48V _{DC} zoom	134	81-04032	Driver	65
794-189C	Microperfetto Large 48V _{DC} zoom	134	81-04034	Driver	65; 243; 245
795-189B	Microperfetto Large 48V _{DC} with lens	134	81-04038	Driver	243; 245
795-189C	Microperfetto Large 48V _{DC} with lens	134	81-04039	Driver	243; 245
795-389B	Microperfetto Large 48V _{DC} with lens	134	81-04040	Driver	65
795-389C	Microperfetto Large 48V _{DC} with lens	134	81-04042	Driver	69-74
81-02408	Driver	68; 106; 184	81-04044	Driver	75-79; 81; 82
81-02413	Driver	75-79; 81; 82; 186	81-04046	Driver	111
81-02464	Driver	53; 55	81-04049	Driver	111
81-02472	Driver	52; 54; 243	81-04054	Driver	242; 244; 261
81-02506	Driver	52-55	81-04055	Driver	242; 244; 261
81-02517	Driver	52; 54	81-04056	Driver	216; 218
81-02531	Driver	56; 214; 215	81-04057	Driver	53; 55
81-02565	Driver	53; 55	81-04062	Driver	108
81-02571	Driver	53; 55	81-04063	Driver	108
81-04002	Driver	52; 54; 62-64; 68-70; 72; 75-79; 82; 84; 85; 110; 112; 113	81-04065	Driver	216; 217
81-04003	Driver	52-55; 60; 63; 64; 66; 69-79; 84; 85; 110; 111	81-04066	Driver	75-79; 81; 82; 84; 85
81-04003-250	Driver	61	81-04067	Driver	112
81-04004	Driver	83	81-04068	Driver	112
81-04006	Driver	218; 232	81-04069	Driver	112
81-04007	Driver	69; 70; 72; 243	81-04070	Driver	112

Cod	Name	Pag
81-04071	Driver	112
81-04072	Driver	58; 108; 109
81-04074	Driver	58; 108; 109
81-04075	Driver	58; 108; 109
81-04076	Driver	52-55
81-04077	Driver	53; 55
81-04078	Driver	52; 54
81-04079	Driver	53; 55
81-04080	Driver	53; 55
81-04081	Driver	52; 54
81-04082	Driver	53; 55
81-04083	Driver	53; 55
81-04084	Driver	52; 54
81-09000	Driver	35; 160; 161
81-09001	Driver	35; 160; 161
81-90089	Driver	35; 160; 161
81-90122	Driver	35; 160; 161
81-90123	Driver	35; 160; 161
81-90124	Driver	35; 160; 161
81-90128	Driver	35; 160; 161
84108	Accessory	216-218; 232; 244-246; 248; 249; 251
84109	Accessory	214; 215
84-90380	Accessory	197
84-90390	Accessory	201
84-90400	Accessory	200
84-90420	Accessory	197
84-90430	Accessory	197
84-90450	Accessory	201
91-02603	Driver	205
91-02604	Driver	205
91-90032	Driver	205
93-05087-20	Stripled 180	205
93-05088-20	Stripled 180	205
93-05089-20	Stripled 180	205
93-1540522	Stripled 154	206
93-1540527	Stripled 154	206
93-1540530	Stripled 154	206
93-1540535	Stripled 154	206
93-1540540	Stripled 154	206
93-1540550	Stripled 154	206

Cod	Name	Pag
93-1540565	Stripled 154	206
93-1540922	Stripled 154	206
93-1540927	Stripled 154	206
93-1540930	Stripled 154	206
93-1540935	Stripled 154	206
93-1540940	Stripled 154	206
93-1540950	Stripled 154	206
93-1540965	Stripled 154	206
93-1541322	Stripled 154	206
93-1541327	Stripled 154	206
93-1541330	Stripled 154	206
93-1541335	Stripled 154	206
93-1541340	Stripled 154	206
93-1541350	Stripled 154	206
93-1541365	Stripled 154	206
93-1961627	Stripled 196	207
93-1961630	Stripled 196	207
93-1961635	Stripled 196	207
93-1961640	Stripled 196	207
93-1961650	Stripled 196	207
93-1961665	Stripled 196	207
93-1962427	Stripled 196	207
93-1962430	Stripled 196	207
93-1962435	Stripled 196	207
93-1962440	Stripled 196	207
93-1962450	Stripled 196	207
93-1962465	Stripled 196	207
93-1968522	Stripled 196	207
93-1968527	Stripled 196	207
93-1968530	Stripled 196	207
93-1968535	Stripled 196	207
93-1968540	Stripled 196	207
93-1968550	Stripled 196	207
93-1968565	Stripled 196	207
93-WB948-2520A-30	Accessory	34
93-WC948-2520A-30	Accessory	34
98-13380-61	Accessory	81
K7382-S04	38 Surface Profile	197
K7384-S04	38 Surface Profile	197
K7392-R04	39 Recessed Profile	201

Cod	Name	Pag
K7394-R04	39 Recessed Profile	201
K7402-C04	40 Corner Profile	200
K7404-C04	40 Corner Profile	200
K7422-04	42 Surface Low Profile	197
K7432-04	43 Surface Profile	197
K7443-R04	44 Recessed Trimless Profile	201
K7452-04	45 Recessed Profile	201
K7902-S04	90 Surface Flexi Profile	203
K7912-R04	91 Recessed Profile	202
K7912-R11	91 Recessed Profile	202
K7922-R04	92 Recessed Profile	202
K7932-C04	93 Corner Profile	200
K7942-C04	94 Corner Profile	200
K7942-C09	94 Corner Profile	200
K7952-S04	95 Surface Profile	199
K7952-S11	95 Surface Profile	199
K7962-S04	96 Surface Profile	199
K7972-S04	97 Surface Profile	198
K7972-S09	97 Surface Profile	198
K7982-S04	98 Surface Profile	198
K7982-S11	98 Surface Profile	198
K7982-S12	98 Surface Profile	198
K7982-S13	98 Surface Profile	198
K7992-S04	99 Surface Profile	198

Name	Pag	Name	Pag
35 Track	34	Iconica	186
35 Trentacinque Linear Continuous Element	31	Kardan-IN	84
35 Trentacinque Linear Continuous Element off	33	Kardan-TL	85
35 Trentacinque Linear Master Element	30	Linea 48Vdc	137
38 Surface Profile	197	Lito 230 / Lito	248
39 Recessed Profile	201	LKM Incasso _ Recessed	166
40 Corner Profile	200	LKM Quadro _ Square	165
42 Surface Low Profile	197	LKM Tondo _ Round	164
43 Surface Profile	197	Maxilito	249
44 Recessed Trimless Profile	201	Microperfetto 48Vdc	133
45 Recessed Profile	201	Microperfetto Cupcake	111
48Vdc Incasso TL _ TL Recessed	161	Microperfetto IP66	242; 243
48Vdc Quadro _ Square	160	Microperfetto IP66 Cupcake	244; 245
90 Surface Flexi Profile	203	Microperfetto IP66 Stelo	261
91 Recessed Profile	202	Microperfetto Large 48Vdc	134
92 Recessed Profile	202	Microperfetto Large 48Vdc Zoom	134
93 Corner Profile	200	Microperfetto Large Base Zoom	113
94 Corner Profile	200	Microperfetto Large Broadway with lens	96
95 Surface Profile	199	Microperfetto Large Broadway zoom	97
96 Surface Profile	199	Microperfetto Large LKM	140
97 Surface Profile	198	Microperfetto Large LKM con lente	139
98 Surface Profile	198	Microperfetto Large LKM Zoom	141
99 Surface Profile	198	Microperfetto Large-R	112
Achille 190 LED	219	Microperfetto Large-R Zoom	112
Achille 320 LED	220	Microperfetto LKM	138
Achille 450 LED	221	Microperfetto Low 48Vdc	132
AP Line	173	Microperfetto Low-R	110
Balti 150	270	Miniperfetto Base	114
Balti 220	271	Miniperfetto LKM	142
Balti 260	272	Miniperfetto MM	142
Balti 80	270	Miniperfetto-S	185
Bidi Applique	273	Minirooler 48Vdc	136
Bidi Bollard	263	Minirooler-IN	52; 53
Boma LED	146	Minirooler-TL	54; 55
Broadway	94; 95	MM	167
Dedo 100	251	Nanoperfetto 48Vdc	130
Dino	250	Nanoperfetto Base	109
DKM Incasso _ Recessed	163	Nanoperfetto IN-Ground	214
DKM Quadro _ Square	162	Nanoperfetto IN-Ground asymmetric	215
Floot	188	Nanoperfetto UP	106

Name	Pag	Name	Pag
Nanoperfetto-R	107	RA 4	68
Nanoperfetto-S	184	RA 7	68
Nauto	218	RA 8 Dixit LED	69
Perfetto Box	144	RA 8 IP66 Dixit LED	70
Perfetto Compact	143	RA 8 IP66 tiltable Dixit LED	74
Perfetto Compact-S	185	RA 8 L Dixit LED	69
Perfetto IN-Ground	216	RA 8 L IP65 Dixit LED	70
Perfetto IN-Ground asymmetric	217	RA 8 L TL Dixit LED	72
Perfetto IP66	246	RA 8 Q Dixit LED	71
Perfetto Puro	145	RA 8 Soft Dixit LED	73
Perfetto-IN 40	56	RA 8 tiltable Dixit LED	74
Perfetto-IN 50	57	RA 8 TL Dixit LED	72
Perfetto-IN 50 IP65	57	Stilled	232
Perfetto-IN 60	58	Stripled 154 IP20 / IP65	206
Perfetto-IN 60 IP65/20	59	Stripled 180	205
Perfetto-IN 70	60	Stripled 196 IP20 / IP65	207
Perfetto-IN 70 Wall Washer	61	Wall-Cut 150	231
Perfetto-IN 80	62; 63	Wall-Cut 80	230
Perfetto-IN 90	64	Zeppel 400	189
Perfetto-IN 90 IP66	65		
Perfetto-IN 90 IP66/20	66		
PF 15	174		
PF 19	175		
PF 22	174		
PF 30	175		
PN 180	280		
PN 210	281		
PN 230	280		
PN 280	281		
Pole-Cute	262		
RA 11 Dixit LED	75		
RA 11 Q Dixit LED	76		
RA 11 Soft Dixit LED	78		
RA 11 tiltable Dixit LED	79		
RA 11 TL Dixit LED	77		
RA 14 Dixit LED	81		
RA 16	82		
RA 17 Dixit LED	82		
RA 20 Dixit LED	83		
RA 23SP Dixit LED	83		

Condizioni generali di vendita

Gli ordini si intendono accettati ai prezzi e alle condizioni di vendita in vigore. A fronte di eventuali variazioni di listino e quindi di prezzi e condizioni, l'acquirente avrà la facoltà di annullare gli ordini in atto con comunicazione scritta entro 8 giorni dalla nostra informazione di variazione. Gli ordini si intendono subordinati alla nostra accettazione.

I prezzi di listino si intendono franco nostri magazzini di fabbrica, salvo accordi speciali.

Ogni nostra obbligazione cessa con la consegna della merce al vettore o allo spedizioniere. Il trasporto o la spedizione con qualsiasi mezzo si intendono sempre effettuati a rischio e pericolo dell'acquirente, con esclusione di ogni nostra responsabilità in caso di rotture, avarie, furti o manomissioni.

I termini di consegna, ove pattuiti, si intendono sempre indicativi.

L'azienda si riserva il diritto di apportare qualsiasi modifica alla propria produzione senza preavviso.

Sono possibili esecuzioni personalizzate. Sono richiesti minimi d'ordine.

È vietata la riproduzione anche parziale di questo catalogo.

IVELA srl garantisce i prodotti del seguente catalogo per un termine di 2 anni dalla data di acquisto purché installati correttamente, e utilizzati nei limiti e in conformità alle specifiche tecniche dei componenti e alle prescrizioni del foglio di istruzione.

In caso di contestazione si stabilisce la competenza esclusiva dell'Autorità Giudiziaria di Milano.

ARIA si riserva la facoltà di modificare, in qualsiasi momento e senza preavviso, le caratteristiche tecniche dei modelli illustrati nel presente catalogo.

General sale terms and conditions

Purchase orders are considered accepted at the sale prices and conditions at the time. In the event of a variation in price, terms and conditions at the point of sale, the purchaser shall have the right to cancel the orders placed at this time. Orders must be cancelled within eight days of receipt of such a variation. All purchase orders shall be considered accepted once Aria have given written confirmation.

All prices quoted in the price list are ex works unless otherwise agreed upon.

Aria are not liable for the goods at the moment they are handed over to the carrier for shipment. Carriage or shipment of goods by whatever transport or shipping means shall be always considered at the risk and responsibility of the purchaser. Aria shall not be considered liable for breakages, faults, thefts or alteration to said goods.

Delivery terms agreed upon are always to be considered indicative.

We reserve the right to alter our products without prior notification.

Customizations are possible. Minimum quantities required.

It is forbidden to reproduce any part of this catalogue.

IVELA srl guarantee the products of the current catalogue for a 2 year period from the data of purchase, provided that the installation is correct, and that the products are used within the limits and in conformity with the technical features of their components and with the requirements of the installation sheet.

All orders to which these Conditions of Sale apply, shall be governed by and construed in accordance with Italian Law.

ARIA reserves the right to change, at any time and without prior warning, the technical specifications of any product illustrated in this catalogue.

Note

ARIA – Member of Starlight Group

**Via B. Buozzi, 15 – 20050
Liscate (MI) - Italy
Ph +39 02 9500121
Fax +39 02 95001205
aria@aria.lighting**

aria.lighting

Art Direction	Publifarm srl ARIA Marketing & Communication Dept.
Fotografie	Bordegoni srl Paolo Carlini Photographer Nele Martensen Mattia Aquila Photography Seven Zhang Angelo Talia
Pre-press e stampa Finito di stampare	Arti Grafiche Alpine srl 2022

